

Line

Bathroom Accessories

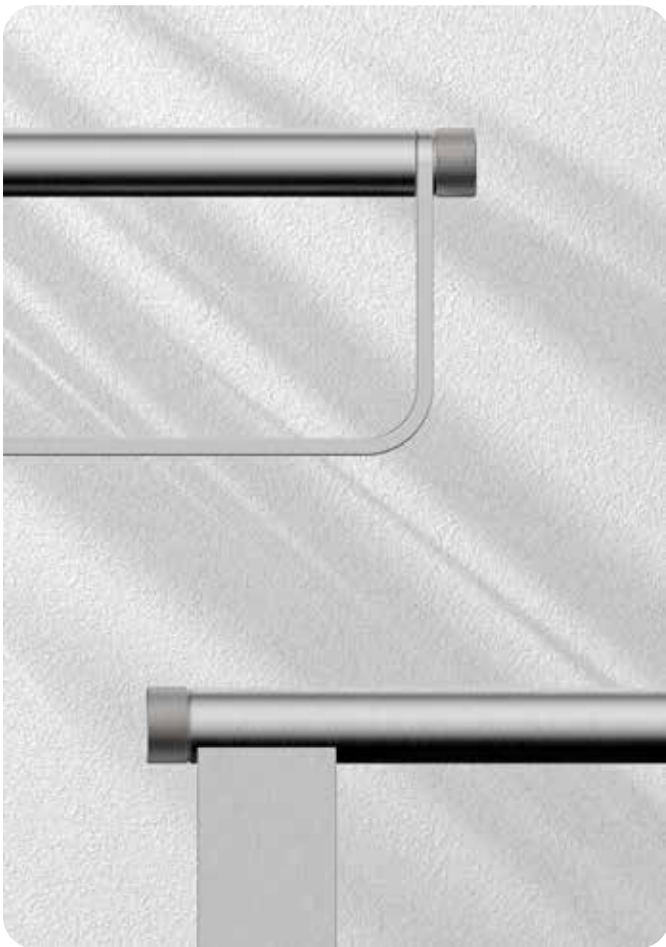

“Your Dream Bathroom Lines”

by **Global**
Line

2025-26
product catalog

About Us;

The primary goal of our company, which set out with the principle of designing and producing the Bathroom Lines of your dreams, is quality service and customer satisfaction.

First of all, Line Bathroom, which values people; It takes place in the sector of bathroom accessories and general use stainless wet volume equipment in residences, hotels, hospitals, shopping malls and offices.

By following the innovations with professional team work, it provides solution-oriented approaches to the special demands you imagine and design, and ensures that it coincides with customer needs as a result of R&D studies.

It offers its customers the products it produces and imported in its distinguished dealers, which are increasing day by day.

100% brass and AISI 316, AISI 304, AISI 430 quality stainless steel raw materials are used in the product range.

Line
Bathroom Accessories

GLOBALLINE BATHROOM & HOTEL EQUIPMENT SAN. TİC. LTD. ŞTİ.



Contents

MODELS, WALL MOUNTED	
Averta	8-9
Moon	10-11
Andorra	12-15
Opal	16-21
Prime	22-29
Venüs	30-35
Viona	36-39
Master	40-43
Flower	44-47
Vera	48-49
Minalis	50-51
Asos	52-53

MODELS, COUNTER TOP	
Sharp Line	56-57
Rosella	58-61
Rounded	62-71
Diamond	72-73

MODELS, COMPLEMENTARY	
Free Standing	76-79
Toilet Brush Set	80-85
Dust Bin	86-99
Soap DISPENSER	100-111
Soap Basket	112-121
Magnifying Mirrors	122-125
Towel Rack	126-128
Clothes Line	129
Kleenex Box	130-135
Kleenex Box	135
Grap Bar	136-137

HOTEL EQUIPMENT	
Hair Dryers	140-145
Trays And Kettles	146-147
Coffee Machine	148
Electronic Safe	149
Mini Bars	150-153
Folding Luggage Rack For Room	154-155
Ironing Table And Vacuum Cleaner	156-157
Cleaning Trolley	158-160
Shoe Polishing Machine And Barriers	161
Other Equipment	162
Leather Products	164-167

GENERAL USE	
Towels & Waste Combination Units	170-175
Towels & Waste Dispensers Photocell	176-177
Towels & Waste Dispensers	178-181
Hand Dryers	182-183
Paper Holders	184-187
Seat-Cover Dispenser	188-189
Big Dust Bin	190-197
Recycling Units	198-199
Trash Bins With Ashtray Bins	200-203
Umbrella Boxes	204
Flower Pot Box	205
Washing Units	206-207
Washing Units	208
Water Dispenser	209
Baby Changing Units	210-211

DISABLED EQUIPMENT	
Grap Bar	214-216
Shower Seats	217-218
Mirrors	219

FAUCET	
Photocell Bataryes	222-223

BEACH, POOL SHOWERS	
	226-231

STAINLESS TOILETS	
	232-233

MODELS, ECONOMIC	
Open	236-237
LED MIRRORS	
Economic Mirrors	259

REFERENCES	
	260-264

BATHROOM DIMENSIONS	
	265

TRADEMARK CERTIFICATE	
	266

The background of the slide is a light-colored marble pattern with grey and white veins. The text is centered on the right side of the page.

Models, Wall Mounted

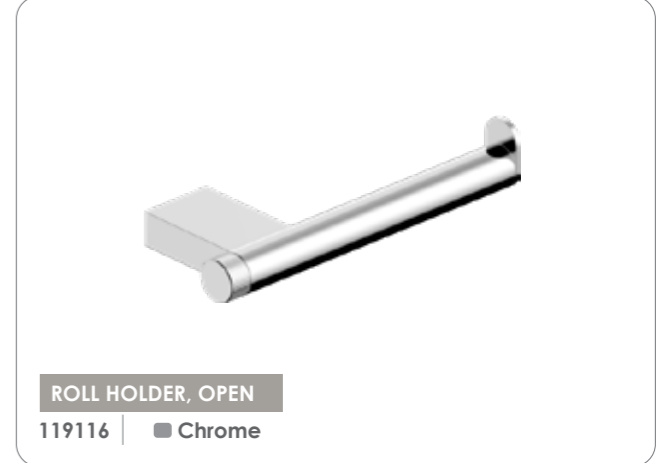
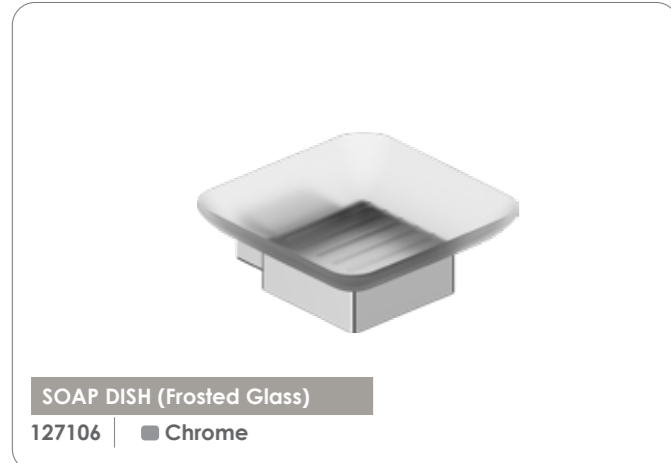
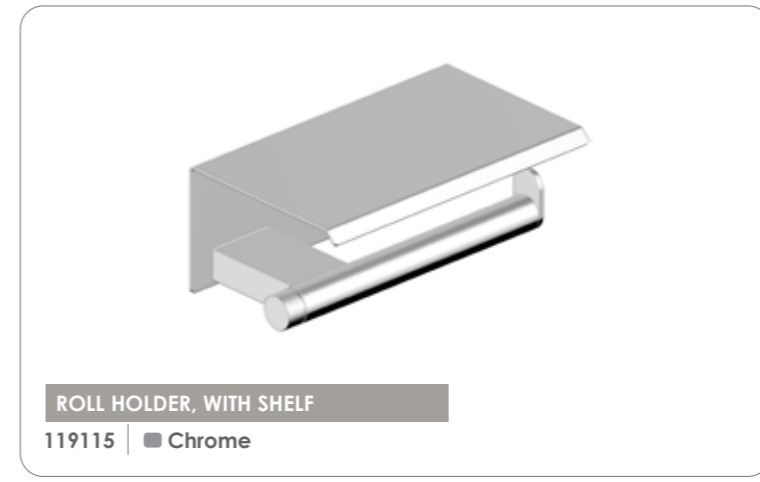
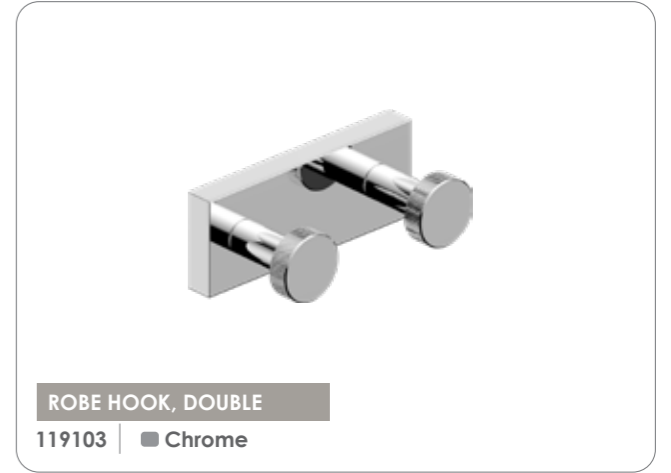
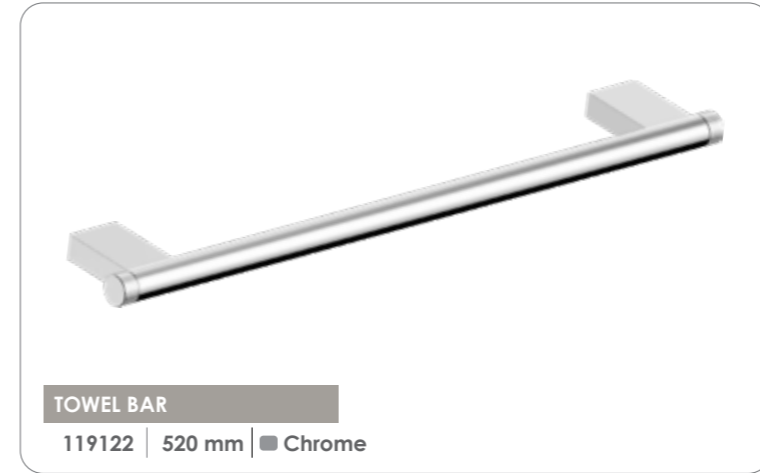
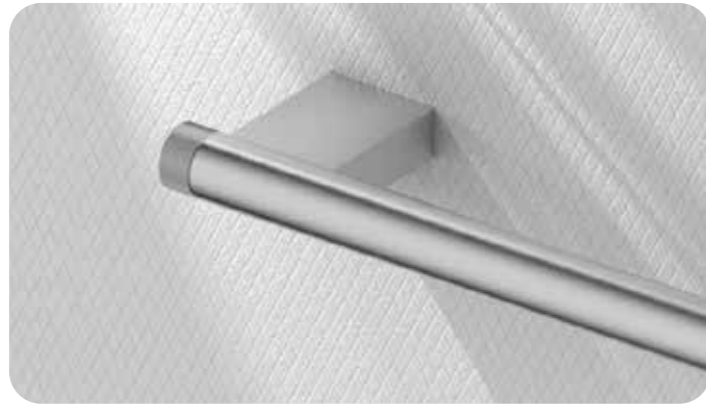
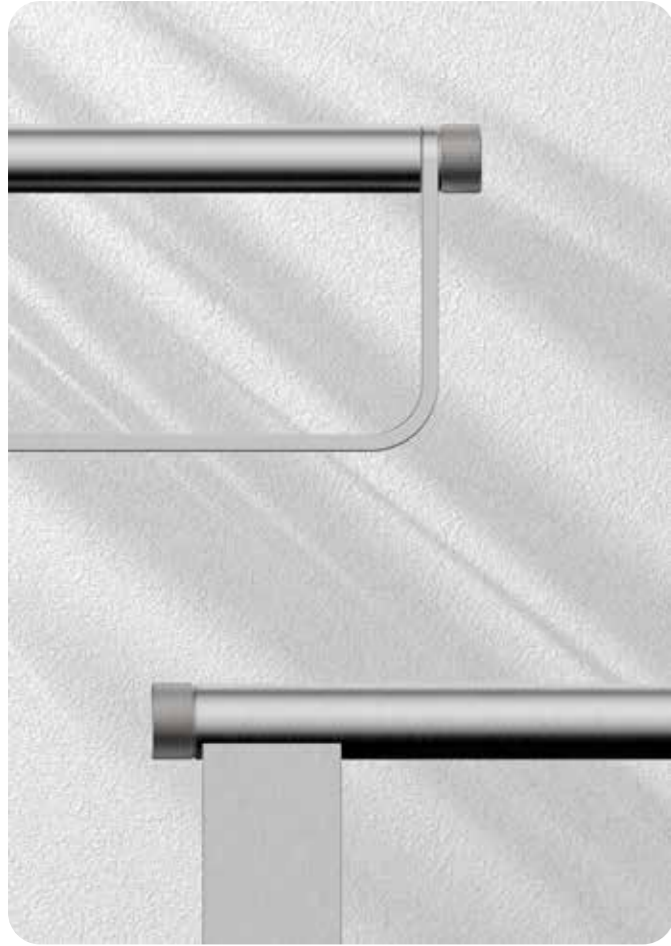



TOWEL BAR
127122 | 490 mm | Chrome

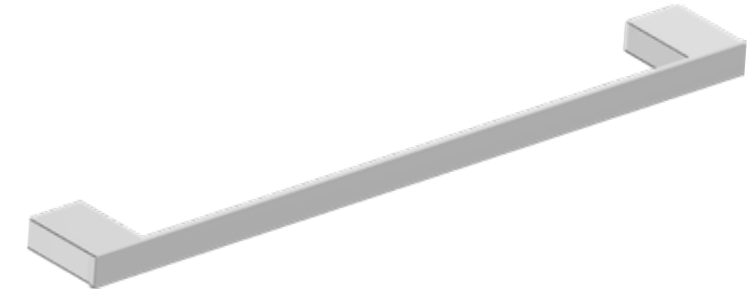

ROLL HOLDER, OPEN
127128 | 210 mm | Chrome

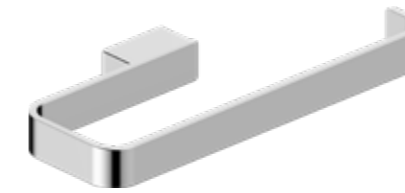

ROBE HOOK

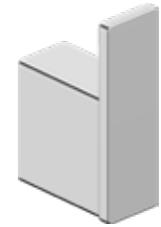

ROLL HOLDER, WITH SHELF
127129 | 210 mm | Chrome

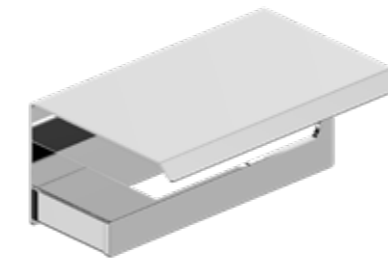

ROBE HOOK, DOUBLE
127130 | 210 mm | Chrome

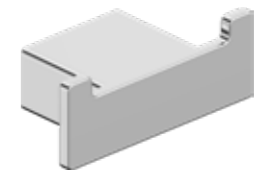

TUMBLER HOLDER (Frosted Glass)
127131 | 100 mm | Chrome

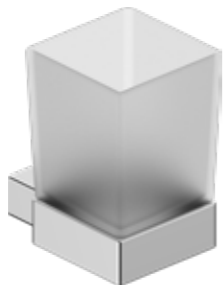

SOAP DISH (Frosted Glass)
127132 | 100 mm | Chrome

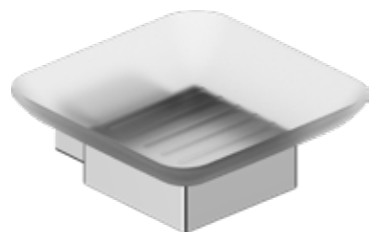

WC BRUSH SET (Frosted Glass)
127133 | 100 mm | Chrome



SOAP DISPENSE (Frosted Glass)
127134 | 100 mm | Chrome



ROLL HOLDER, OPEN
127135 | 210 mm | Chrome

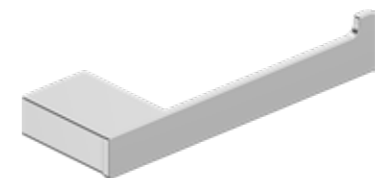

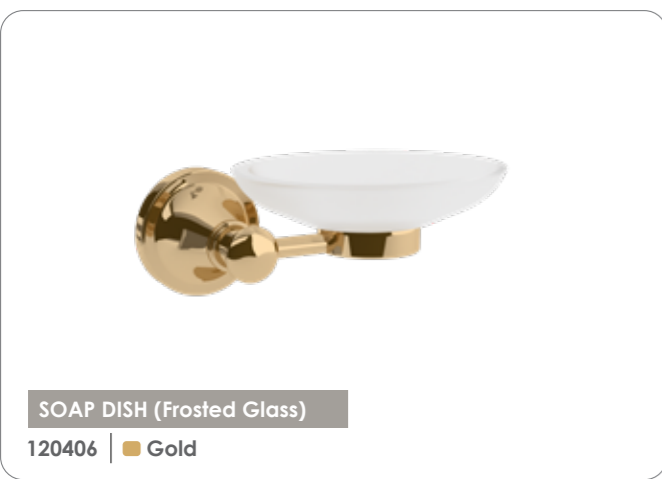
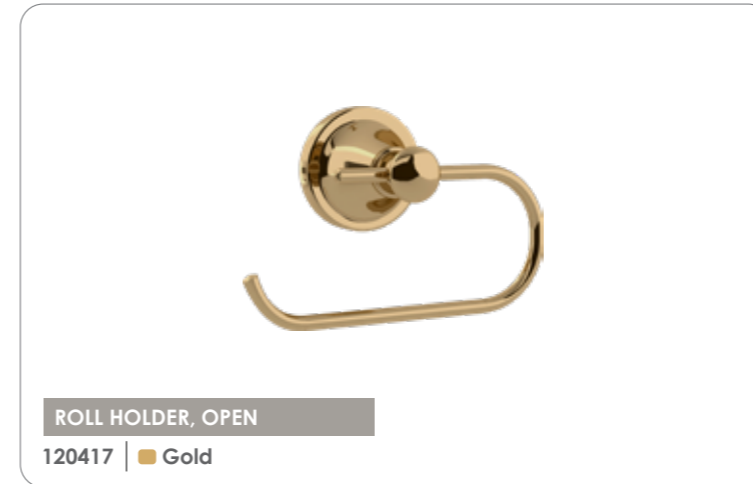
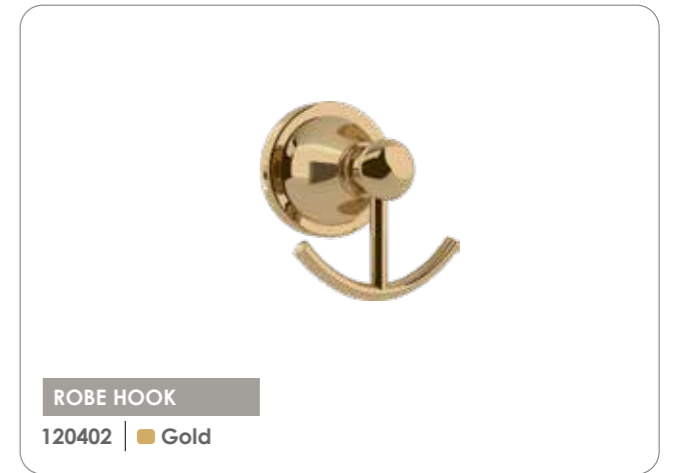
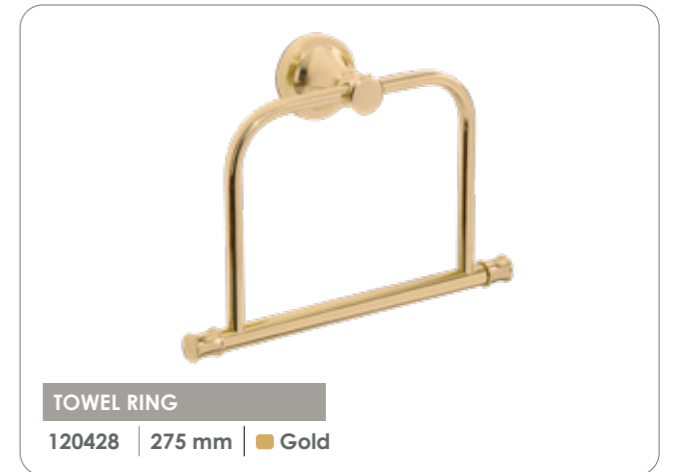

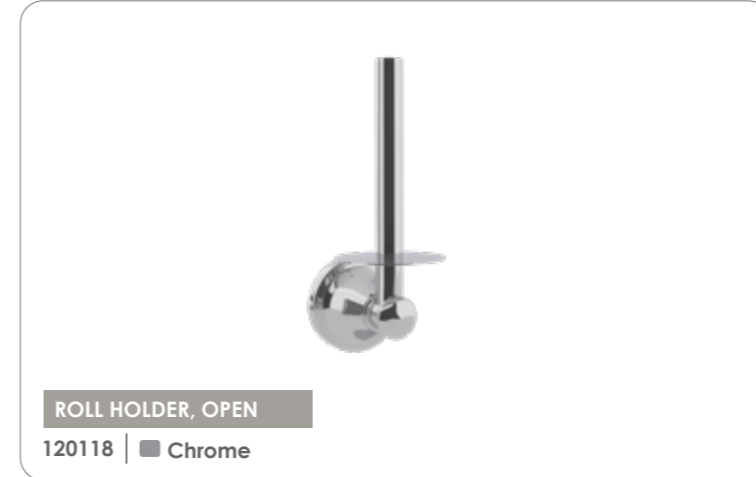
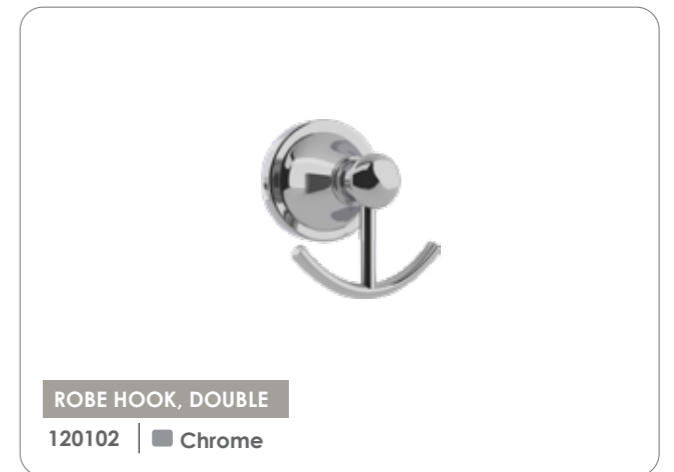
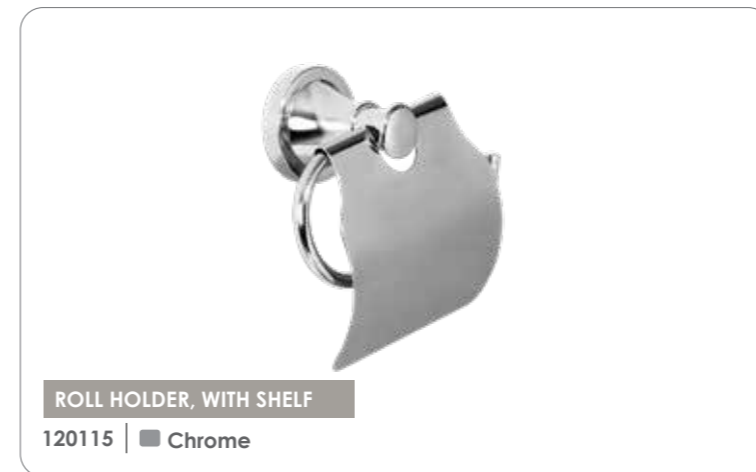

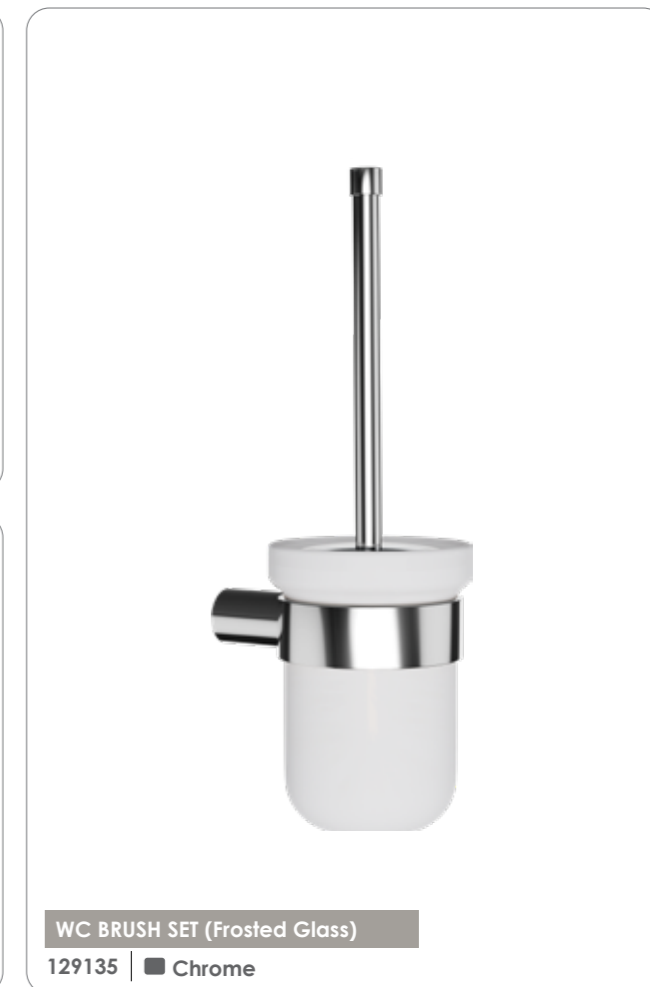
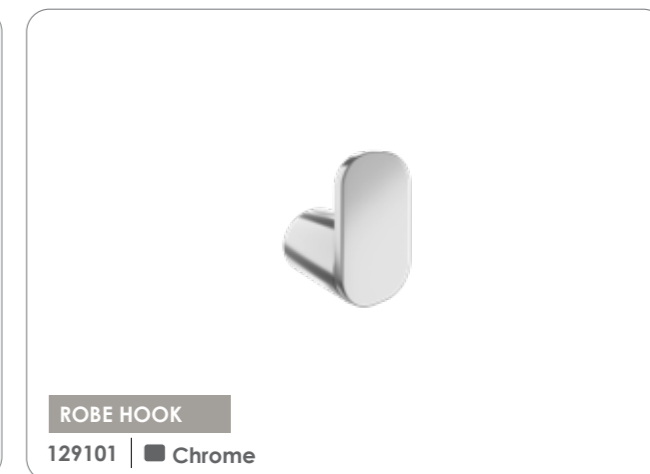
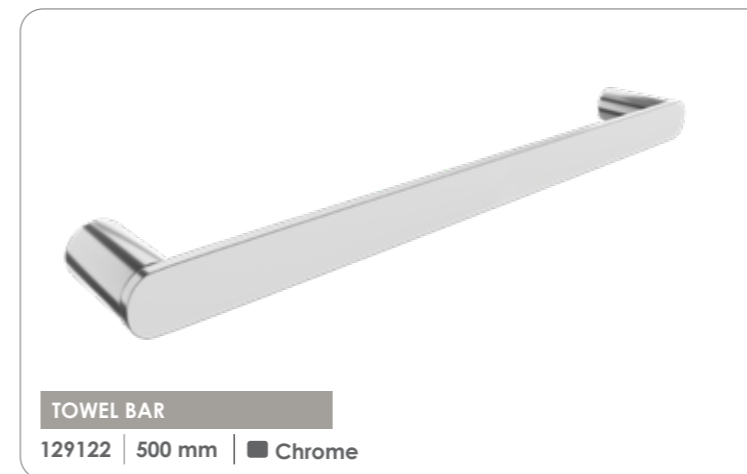

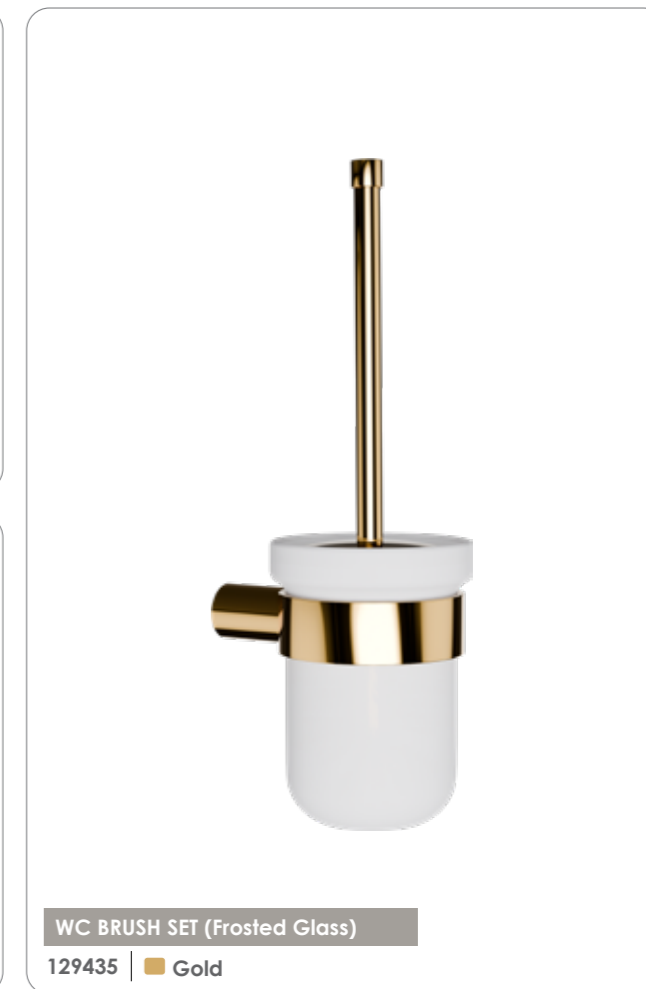
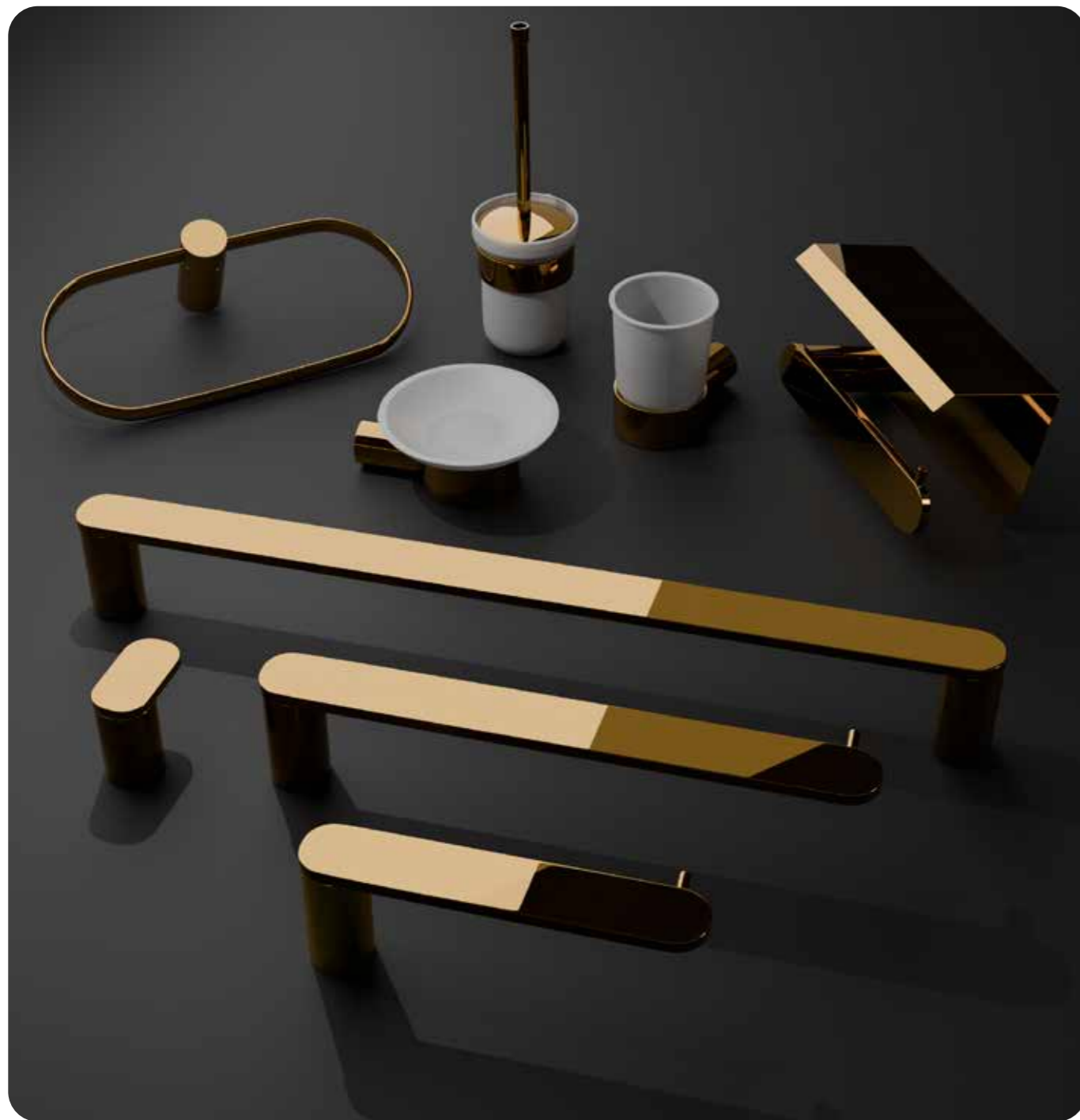



TOWEL BAR
129522 | 500 mm | ■ Matte Anthracite



ROBE HOOK, DOUBLE
129501 | ■ Matte Anthracite



TOWEL RING
129528 | 245 mm | ■ Matte Anthracite



ROLL HOLDER, OPEN
129530 | ■ Matte Anthracite



ROLL HOLDER, WITH SHELF
129515 | ■ Matte Anthracite



WC BRUSH SET (Frosted Glass)
129535 | ■ Matte Anthracite



SOAP DISH (Frosted Glass)
129506 | ■ Matte Anthracite



TUMBLER HOLDER (Frosted Glass)
129507 | ■ Matte Anthracite



ROLL HOLDER, OPEN
129516 | ■ Matte Anthracite

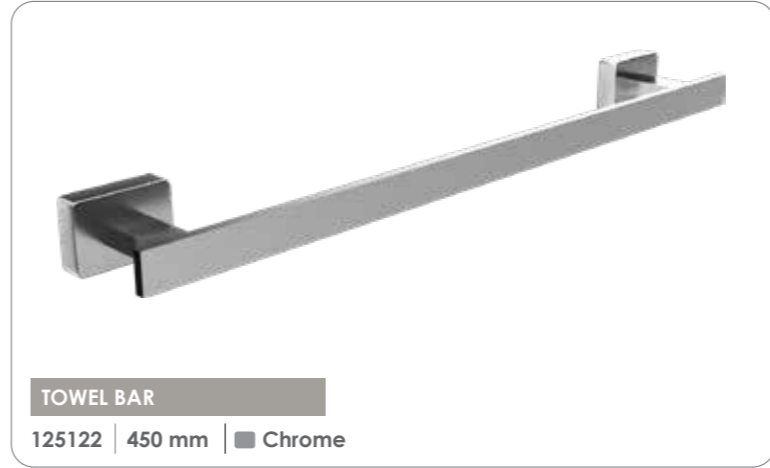

TOWEL BAR
125122 | 450 mm | Chrome

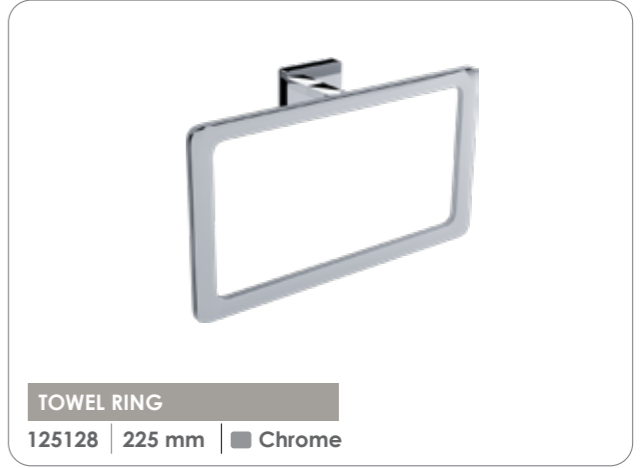

TOWEL RING
125128 | 225 mm | Chrome



ROLL HOLDER, OPEN
125116 | Chrome



ROBE HOOK, DOUBLE
125102 | Chrome



ROLL HOLDER, WITH SHELF
125115 | Chrome



WC BRUSH SET (Frosted Glass)
125135 | Chrome



SOAP DISH (Frosted Glass)
125106 | Chrome

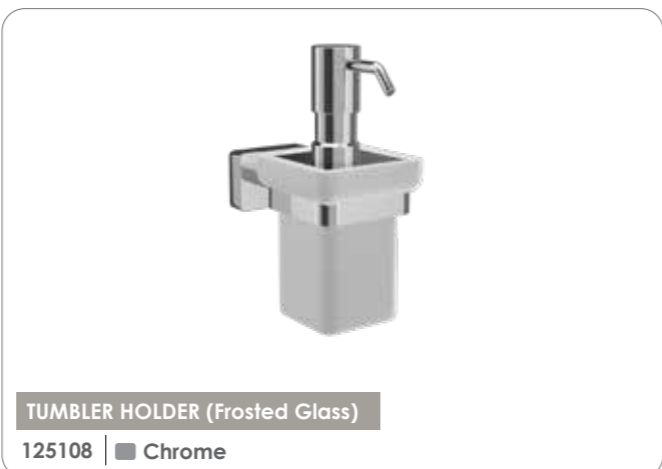

TUMBLER HOLDER (Frosted Glass)
125108 | Chrome



TUMBLER HOLDER (Frosted Glass)
125107 | Chrome

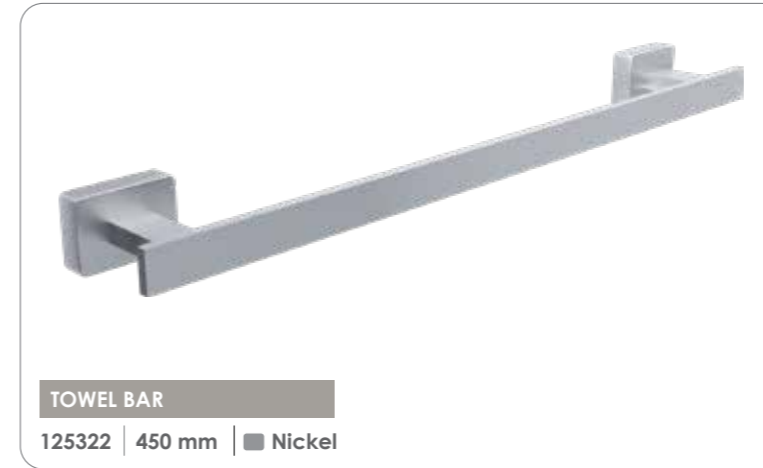

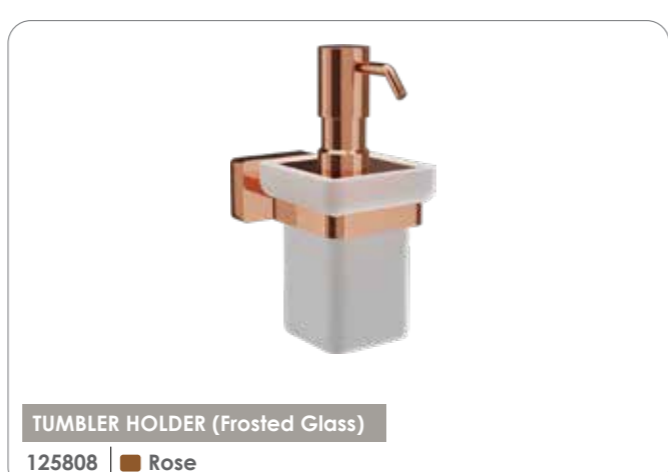
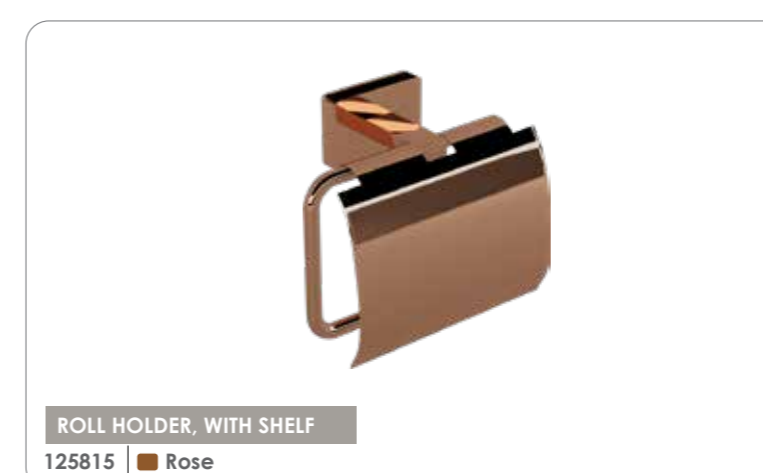
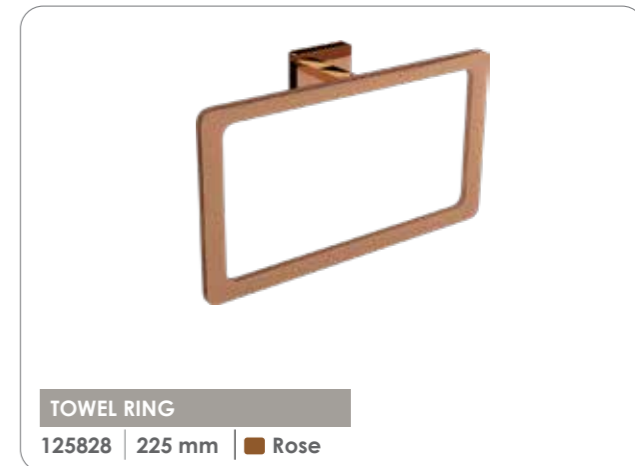
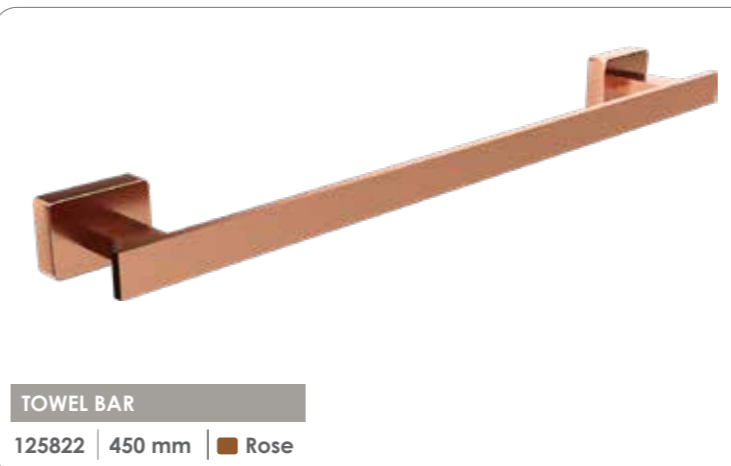
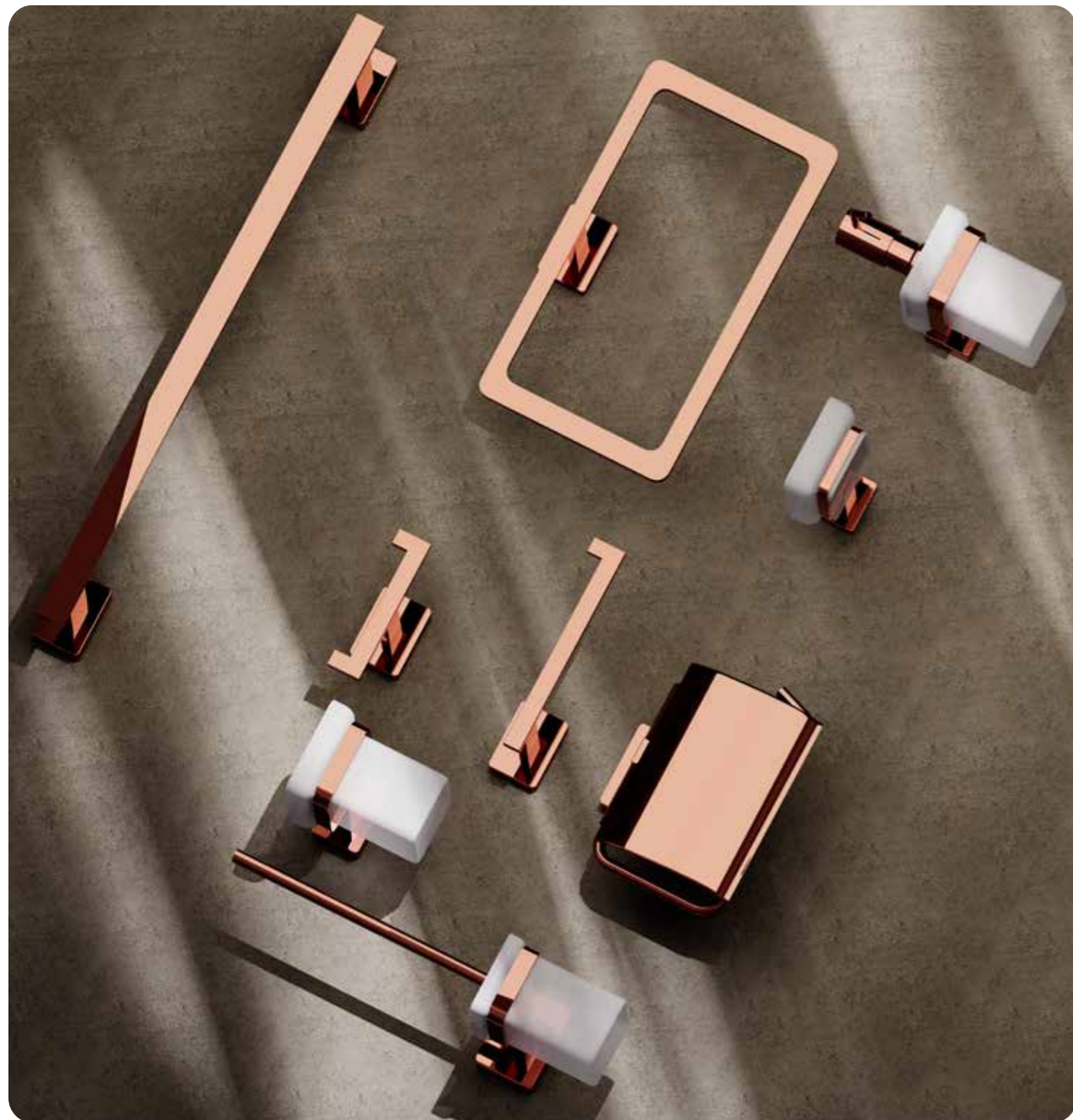

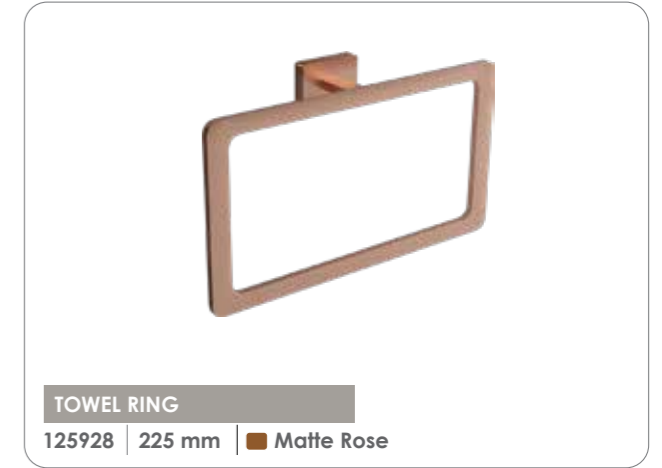
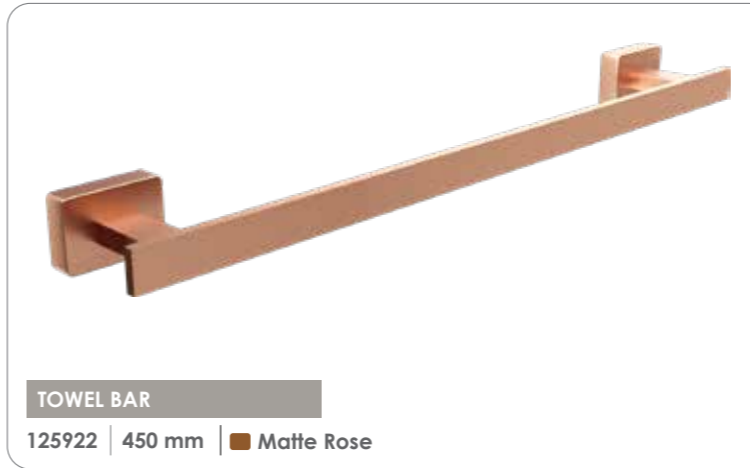



TOWEL BAR
124122 | 460 mm | Chrome

ROLL HOLDER, OPEN
124131 | 275 mm | Chrome

ROBE HOOK, DOUBLE
124102 | Chrome

TUMBLER HOLDER (Frosted Glass)
124107 | Chrome

SOAP DISH (Frosted Glass)
124106 | Chrome

WC BRUSH SET (Frosted Glass)
124135 | Chrome

ROLL HOLDER, OPEN
124129 | 225 mm | Chrome

ROLL HOLDER, OPEN
124116 | Chrome

ROLL HOLDER, OPEN
124117 | Chrome

ROLL HOLDER
124115 | Chrome



TOWEL BAR
124422 | 460 mm | Gold





TOWEL BAR
124722 | 460 mm | ■ Matte Gold

TOWEL RING, OPEN
124731 | 275 mm | ■ Matte Gold

ROBE HOOK, DOUBLE
124702 | ■ Matte Gold

TUMBLER HOLDER (Frosted Glass)
124707 | ■ Matte Gold

WC BRUSH SET (Frosted Glass)
124735 | ■ Matte Gold

SOAP DISH (Frosted Glass)
124706 | ■ Matte Gold

TOWEL RING, OPEN
124729 | 225 mm | ■ Matte Gold

ROLL HOLDER, OPEN
124716 | ■ Matte Gold

ROLL HOLDER, OPEN
124717 | ■ Matte Gold

ROLL HOLDER
124715 | ■ Matte Gold

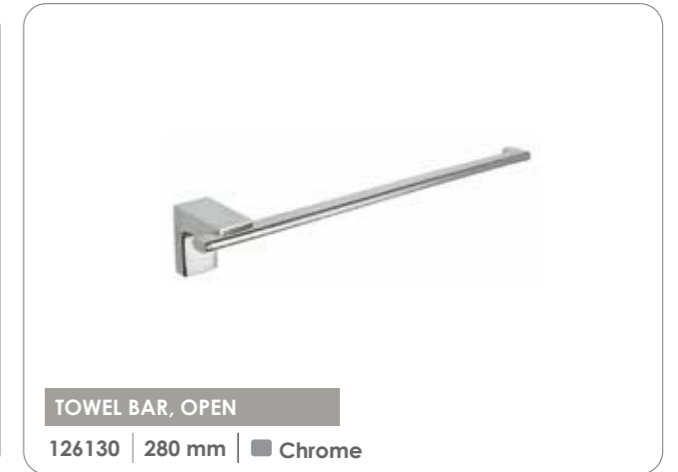

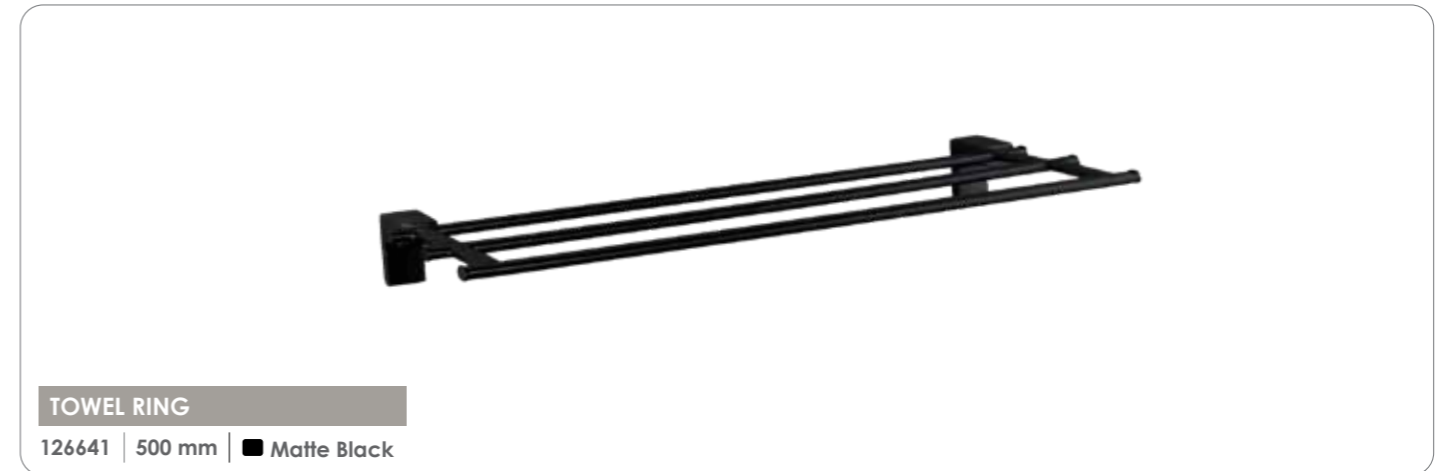



TOWEL BAR
128121 | 400 mm | Chrome
128122 | 500 mm | Chrome

TOWEL RING
128128 | Ø175 mm | Chrome

ROBE HOOK, SMALL
128101 | Ø 20 mm | Chrome

ROBE HOOK, DOUBLE
128104 | Chrome

ROBE HOOK
128103 | Chrome



TUMBLER HOLDER (Frosted Glass)
128106 | Chrome



WC BRUSH SET (Frosted Glass)
128135 | Chrome



WC BRUSH SET
33501 (304) Floor | Parlak P.Çelik
33502 (304) Wall | Parlak P.Çelik



SOAP DISH (Frosted Glass)
128107 | Chrome

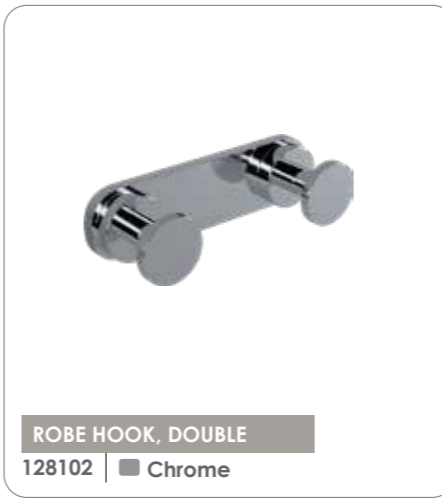

ROBE HOOK, DOUBLE
128102 | Chrome

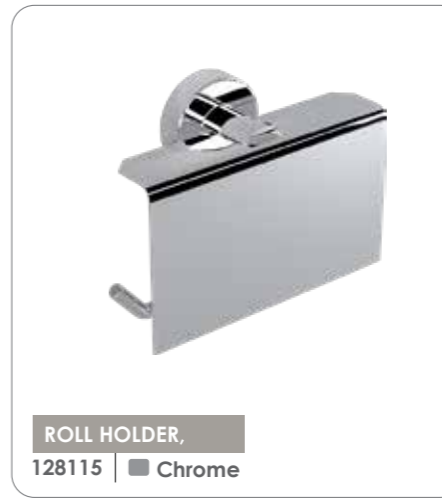

ROLL HOLDER,
128115 | Chrome



ROLL HOLDER, OPEN
128117 | Chrome



SOAP DISPENSER
34559 | 200 mm | Chrome

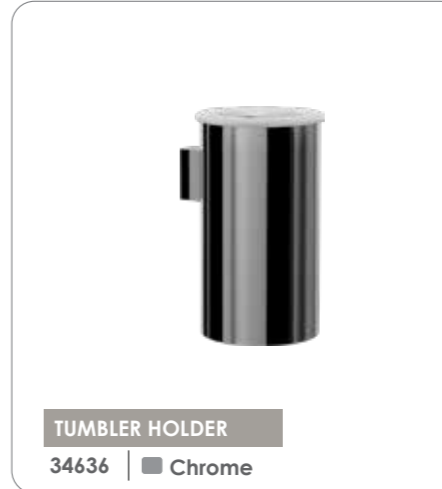

TUMBLER HOLDER
34636 | Chrome

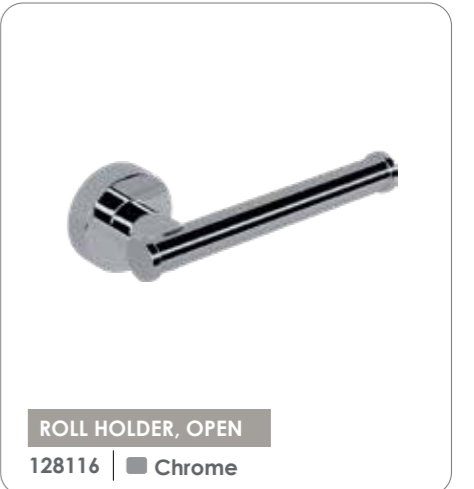

ROLL HOLDER, OPEN
128116 | Chrome

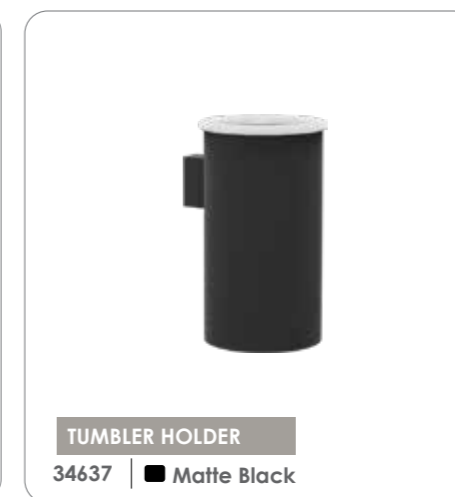
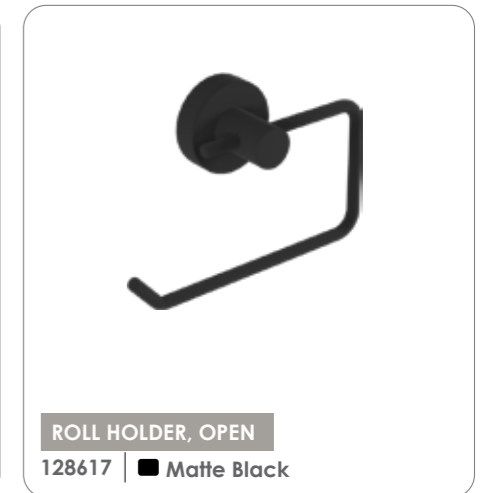
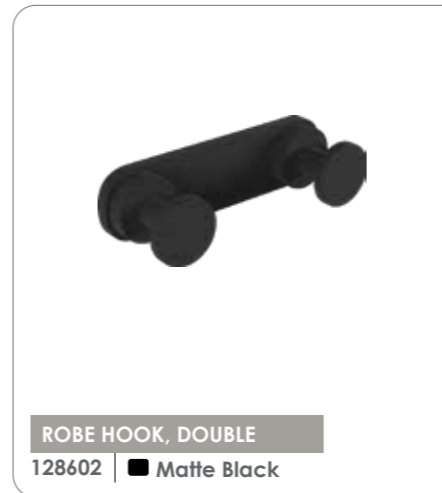
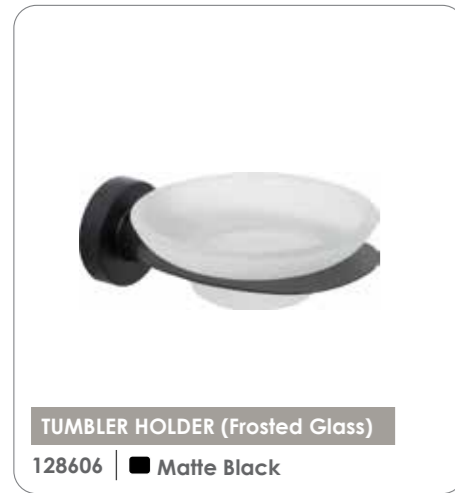
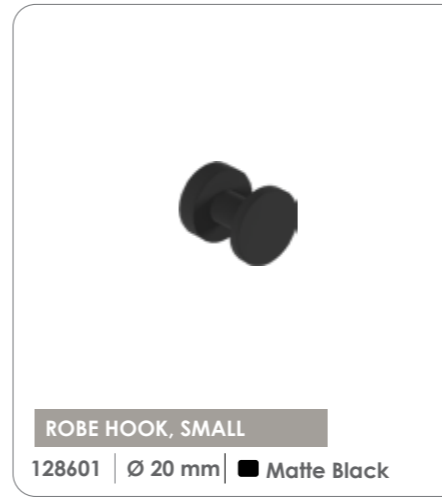
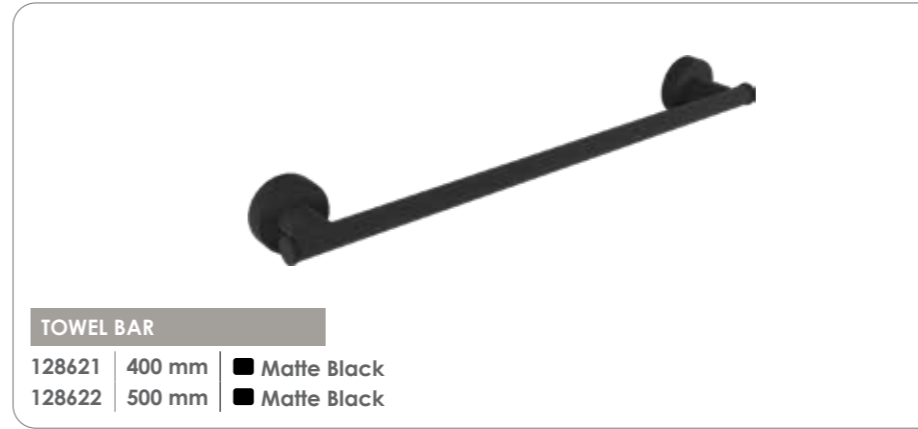

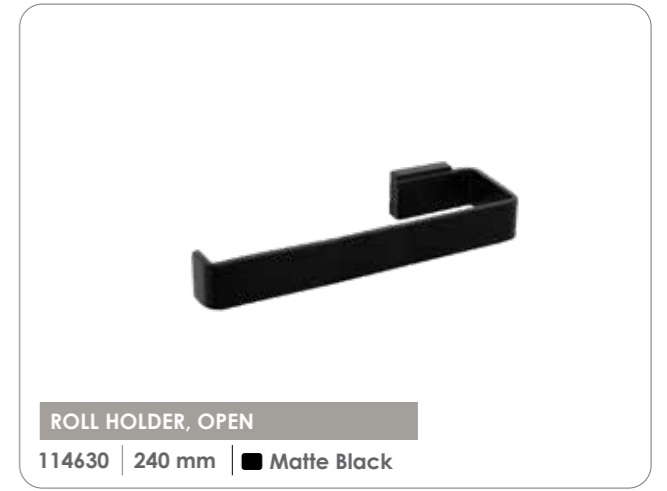

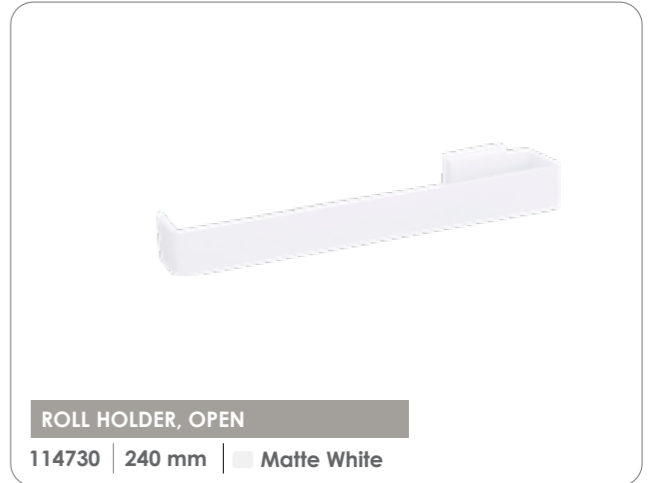

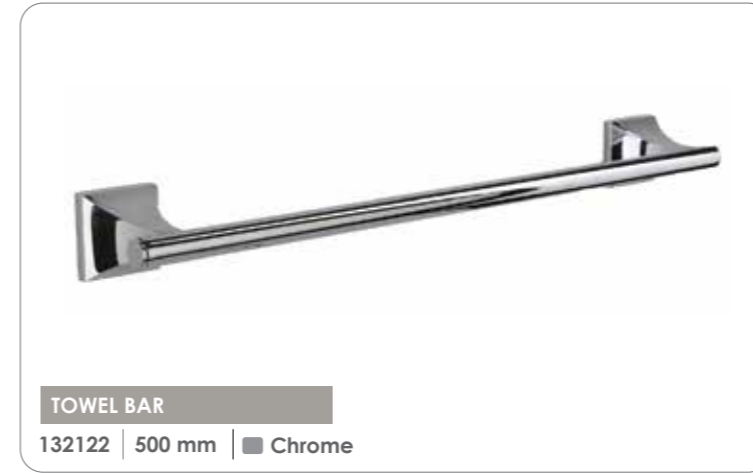
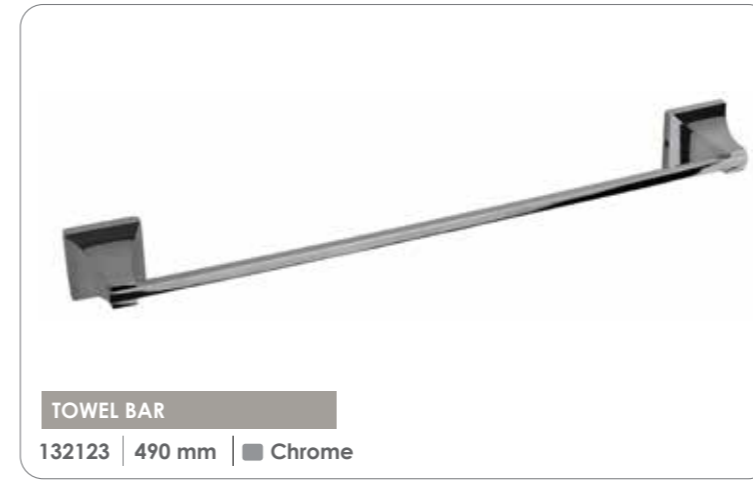



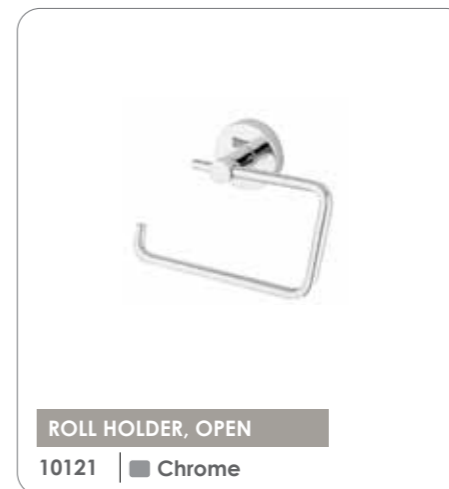
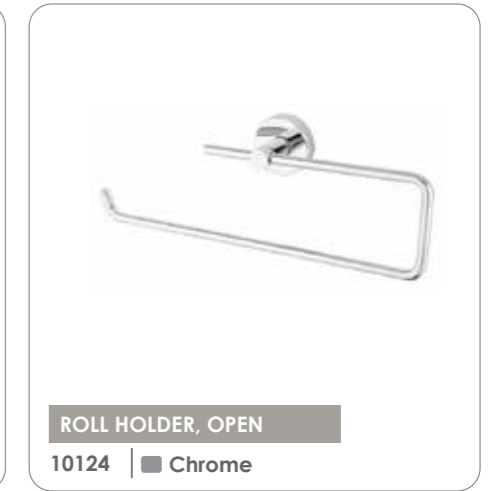
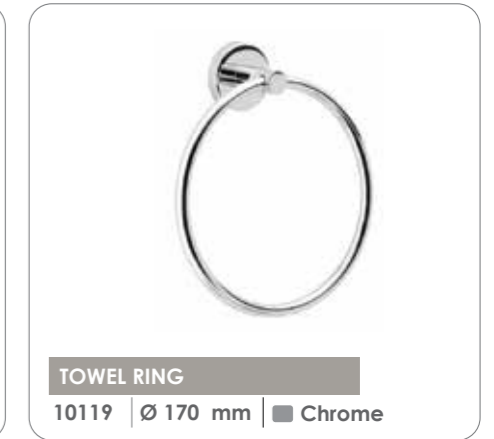
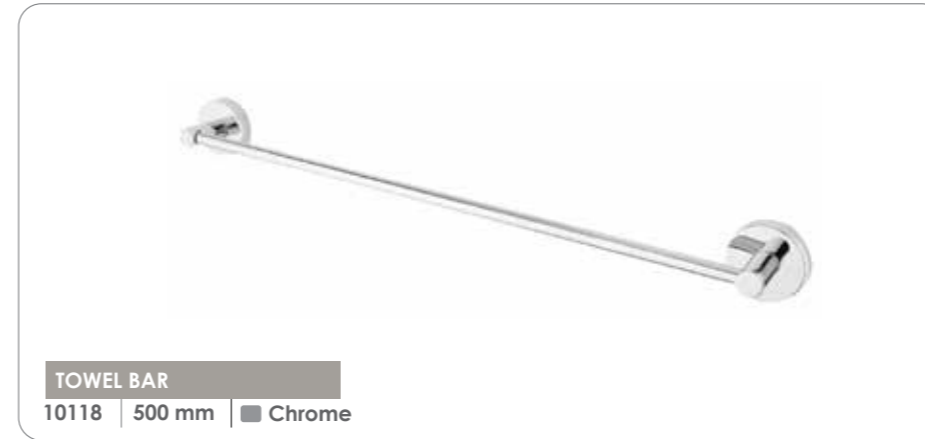
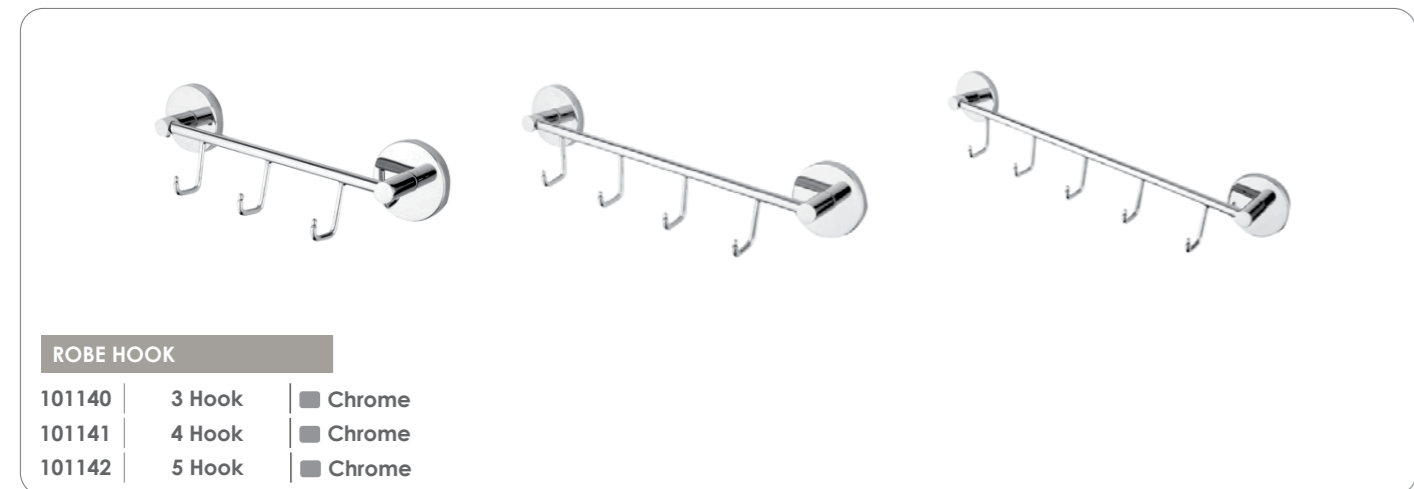
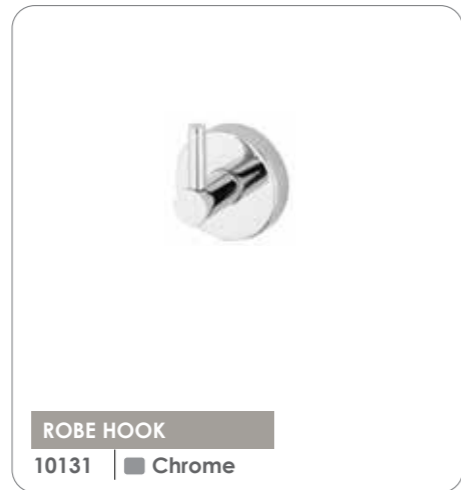
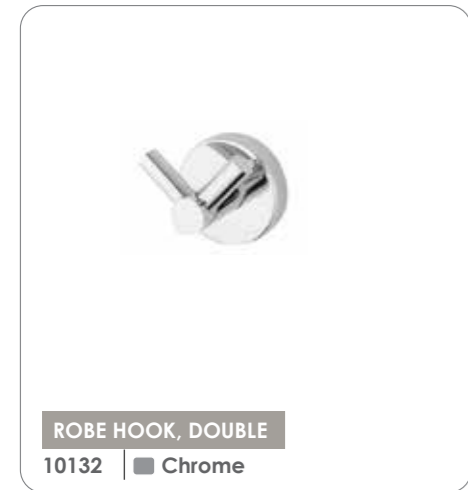
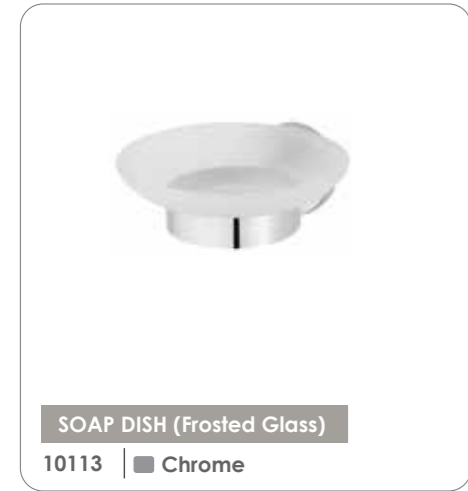

The background of the image is a light-colored, marbled pattern with soft, wavy veins in shades of grey and white, resembling natural stone or a high-quality paper texture.

Models
Table Top



SOAP DISPENSER, COUNTER TOP

- 208112 ■ Crystal Chrome
- 208412 ■ Crystal Gold
- 208812 ■ Crystal Rose



COSMETIC CUBE, COUNTER TOP

- 208113 ■ Crystal Chrome
- 208413 ■ Crystal Gold
- 208813 ■ Crystal Rose

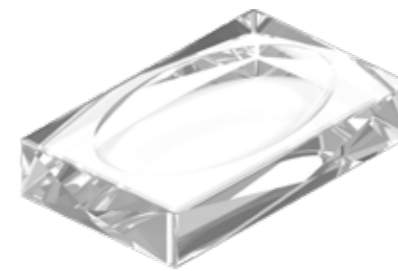

SOAP DISH, COUNTER TOP

- 208110 □ Crystal Transparent



TUMBLER HOLDER, COUNTER TOP

- 208111 □ Crystal Transparent



SOAP DISPENSER, COUNTER TOP
 207112 ■ Crystal Green Chrome
 207412 ■ Crystal Green Gold
 207812 ■ Crystal Green Rose



COSMETIC CUBE, COUNTER TOP
 207113 ■ Crystal Green Chrome
 207413 ■ Crystal Green Gold
 207813 ■ Crystal Green Rose



SOAP DISH, COUNTER TOP
 207210 ■ Crystal Green



TUMBLER HOLDER, COUNTER TOP
 207211 ■ Crystal Green

SOAP DISPENSER, COUNTER TOP

- 206112 ■ Crystal Pink Chrome
- 206412 ■ Crystal Pink Gold
- 206812 ■ Crystal Pink Rose



COSMETIC CUBE, COUNTER TOP

- 206113 ■ Crystal Pink Chrome
- 206413 ■ Crystal Pink Gold
- 206813 ■ Crystal Pink Rose



SOAP DISH, COUNTER TOP

- 206210 ■ Crystal Pink



TUMBLER HOLDER, COUNTER TOP

- 206211 ■ Crystal Pink





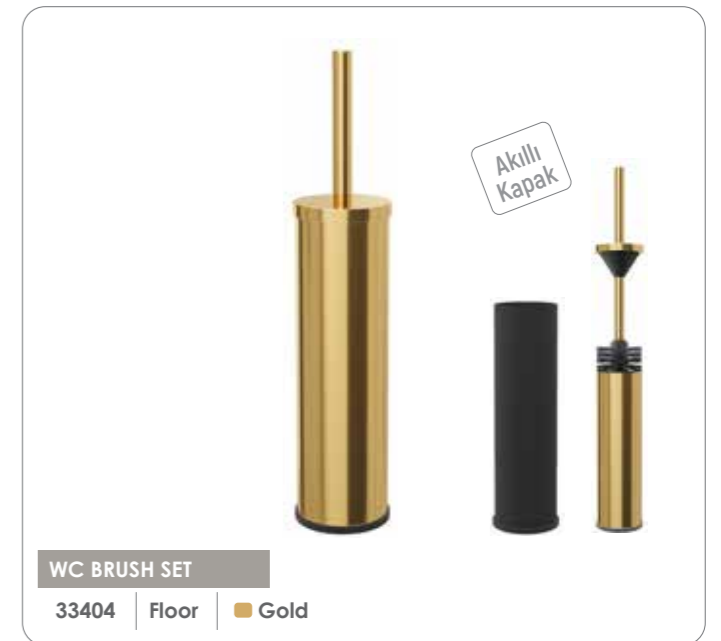
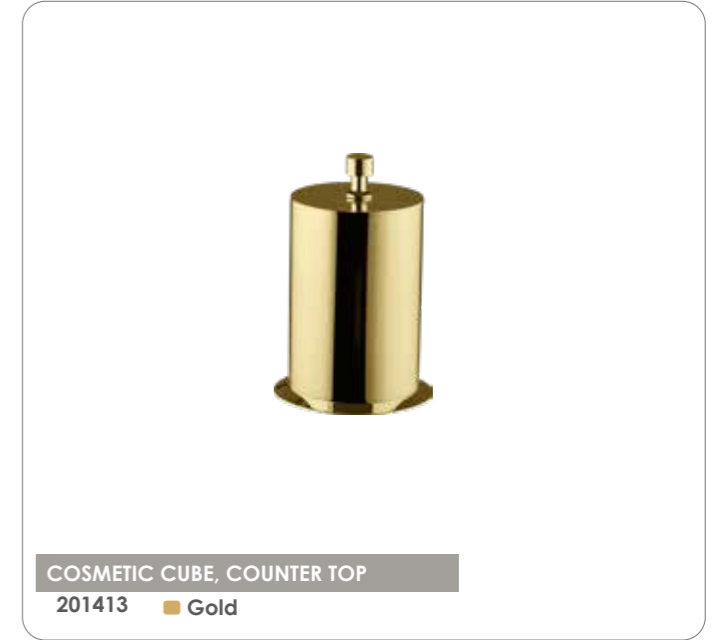
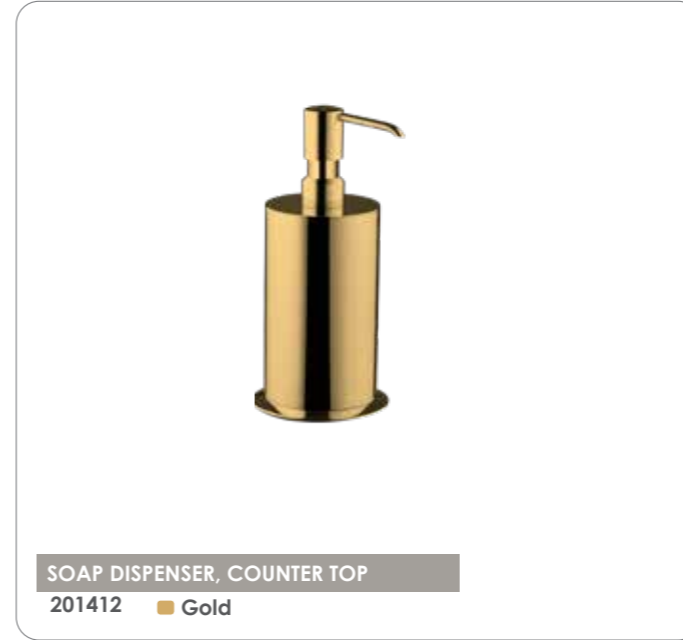



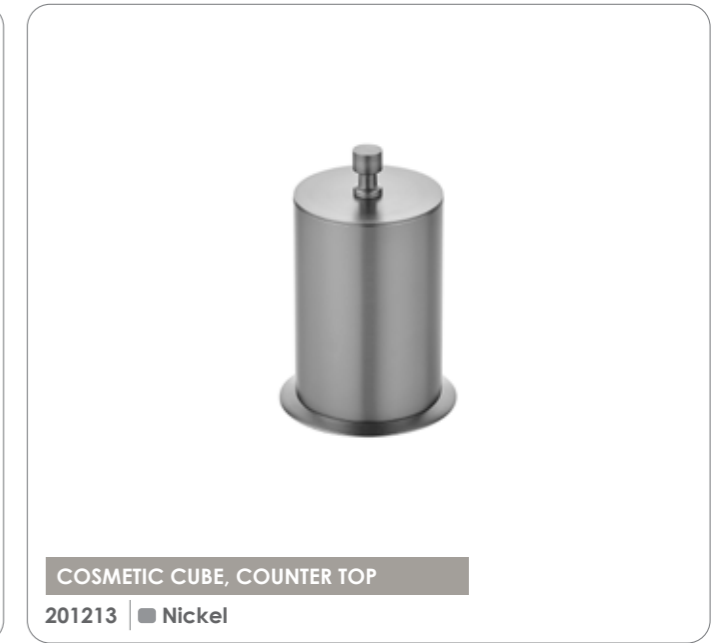

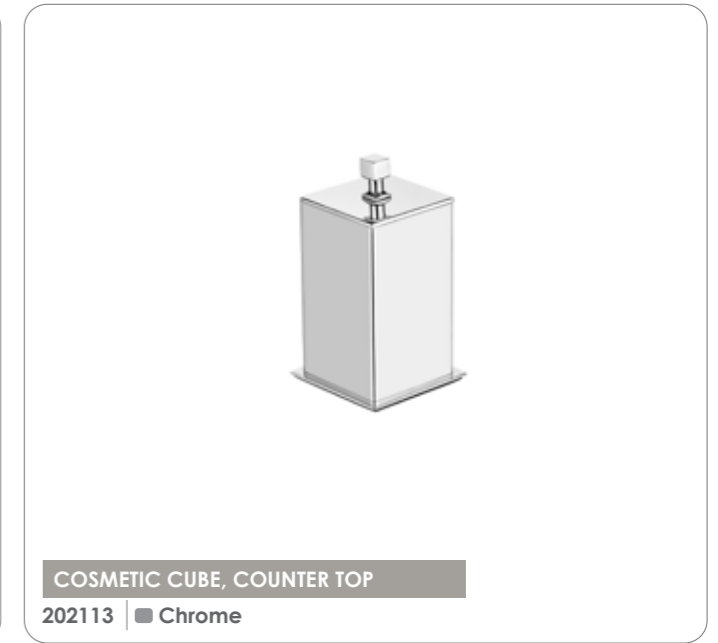
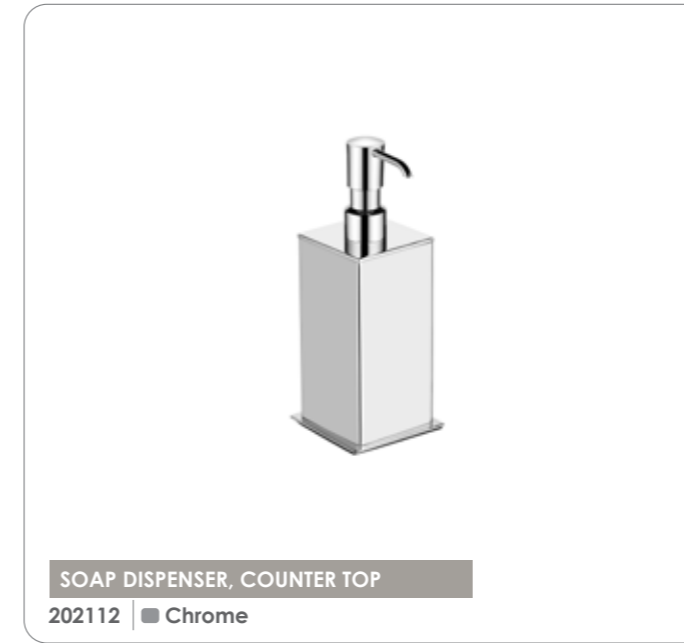

The background of the image is a light-colored, marbled pattern with soft, flowing veins in shades of grey and white, resembling natural stone or marble. The text is centered on the right side of the image.

MODELS,
COMPLEMENTARY





TOWEL STAND
505405 | 850x240x150 mm | Gold

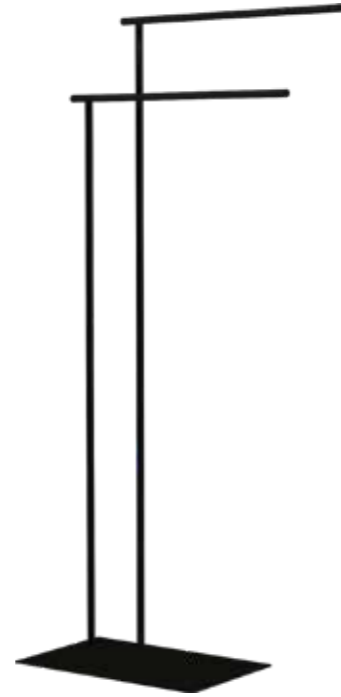

TOWEL STAND
505605 | 850x240x150 mm | M. Siyah



TOILET BRUSH SET
505012 | Chrome



TOILET BRUSH SET
505010 | Polished SS





WC BRUSH SET

33404	360x80 mm	(304) Floor	■ Gold
33405	360x80 mm	(304) Wall	■ Gold

WC BRUSH SET

33406	360x80 mm	(304) Floor	■ Matte Gold
33407	360x80 mm	(304) Wall	■ Matte Gold

WC BRUSH SET

33504	360x80 mm	(304) Floor	■ Polished SS
33505	360x80 mm	(304) Wall	■ Polished SS

WC BRUSH SET

33904	360x80 mm	(304) Floor	■ Nickel
33905	360x80 mm	(304) Wall	■ Nickel

WC BRUSH SET

33804	360x80 mm	(304) Floor	■ Rose
33805	360x80 mm	(304) Wall	■ Rose

WC BRUSH SET

33806	360x80 mm	(304) Floor	■ Matte Rose
33807	360x80 mm	(304) Wall	■ Matte Rose



WC BRUSH SET

33501	380x80 mm	(304) Floor	■ Polished SS
33502	380x80 mm	(304) Wall	■ Polished SS

WC BRUSH SET

33701	380x80 mm	(304) Floor	■ Matte Black
33702	380x80 mm	(304) Wall	■ Matte Black

WC BRUSH SET

33503	360x85x85 mm	(304) Floor	■ Polished SS
33508	360x85x85 mm	(304) Wall	■ Polished SS

WC BRUSH SET

335060	360x85x85 mm	(304) Floor	■ Matte Black
335070	360x85x85 mm	(304) Wall	■ Matte Black



Akılı Kapak

WC BRUSH SET

33522	380x80 mm	(304) Floor	■ Polished SS
33523	380x80 mm	(304) Wall	■ Polished SS



WC BRUSH SET

33506	370x85 mm	(304) Floor	■ Polished SS
33507	370x85 mm	(304) Wall	■ Polished SS



WC BRUSH SET

32601	370x85 mm	(304) Floor	■ Polished SS
32602	370x85 mm	(304) Wall	■ Polished SS



WC BRUSH SET

33513	340x95 mm	(304) Floor	■ Polished SS
-------	-----------	-------------	---------------



WC BRUSH SET

32509	385x80 mm	(304) Floor	■ Polished SS
32510	385x80 mm	(304) Wall	■ Polished SS



WC BRUSH SET

32505	385x80 mm	(304) Floor	■ Polished SS
32507	385x80 mm	(304) Wall	■ Polished SS





 Rotating Cap



WASTE BIN

28488	5 lt. Inner Bin	∅205xh:260	■ Gold
28458	7 lt.	∅205xh:280	■ Gold

 Rotating Cap



WASTE BIN

28490	5 lt. Inner Bin	∅205xh:260	■ Matte Gold
28492	7 lt.	∅205xh:280	■ Matte Gold

 Rotating Cap



WASTE BIN

28888	5 lt. Inner Bin	∅205xh:260	■ Rose
28858	7 lt.	∅205xh:280	■ Rose

 Rotating Cap



WASTE BIN

28890	5 lt. Inner Bin	∅205xh:260	■ Matte Rose
28892	7 lt.	∅205xh:280	■ Matte Rose

 Rotating Cap



WASTE BIN

28588	(304) 5 lt. Inner Bin	∅205xh:260	■ Polished SS
28558	(304) 7 lt.	∅205xh:280	■ Polished SS
28559	(304) 9 lt.	∅250xh:335	■ Polished SS
28560	(304) 12 lt.	∅250xh:370	■ Polished SS

 Rotating Cap



WASTE BIN

28288	5 lt. Inner Bin	∅205xh:260	■ Nickel
28289	7 lt.	∅205xh:280	■ Nickel

 Rotating Cap



WASTE BIN

28688	5 lt. Inner Bin	∅205xh:260	■ Matte Black
28658	7 lt.	∅205xh:280	■ Matte Black

 Rotating Cap



WASTE BIN

28756	5 lt. Inner Bin	∅205xh:260	<input type="checkbox"/> Beyaz
28758	7 lt.	∅205xh:280	<input type="checkbox"/> Beyaz



WASTE BIN OPEN

28452	5 lt. Inner Bin	∅205xh:280	■ Gold
28453	7 lt.	∅205xh:280	■ Gold



WASTE BIN OPEN

28454	5 lt. Inner Bin	∅205xh:280	■ Matte Gold
28460	7 lt.	∅205xh:280	■ Matte Gold



WASTE BIN OPEN

28852	5 lt. Inner Bin	∅205xh:280	■ Rose
28853	7 lt.	∅205xh:280	■ Rose



WASTE BIN OPEN

28854	5 lt. Inner Bin	∅205xh:280	■ Matte Rose
28860	7 lt.	∅205xh:280	■ Matte Rose



WASTE BIN OPEN

28552	(304) 5 lt. Inner Bin	∅205xh:280	■ Polished SS
28553	(304) 7 lt.	∅205xh:280	■ Polished SS
28555	(304) 12 lt.	∅250xh:360	■ Polished SS
28556	(304) 15 lt.	∅250xh:560	■ Polished SS



WASTE BIN OPEN

28252	5 lt. Inner Bin	∅205xh:280	■ Nickel
28253	7 lt.	∅205xh:280	■ Nickel



WASTE BIN OPEN

502645	5 lt. Inner Bin	∅205xh:280	■ Matte Black
502646	7 lt.	∅205xh:280	■ Matte Black



WASTE BIN OPEN

502744	5 lt. Inner Bin	∅205xh:280	□ Beyaz
502746	7 lt.	∅205xh:280	□ Beyaz





WASTE BIN

502139 | (304) 5 lt. | \varnothing 282xh:284 | ■ Polished SS

Soft Cover



WASTE BIN

27515 | (304) 3 lt. | \varnothing 185xh:255 | ■ Polished SS
 27516 | (304) 5 lt. | \varnothing 205xh:280 | ■ Polished SS
 27517 | (304) 8 lt. | \varnothing 205xh:355 | ■ Polished SS
 27518 | (304) 12 lt. | \varnothing 245xh:355 | ■ Polished SS

WASTE BIN

27506 | (304) 3 lt. | \varnothing 185xh:255 | ■ Polished SS
 27507 | (304) 5 lt. | \varnothing 205xh:280 | ■ Polished SS
 27508 | (304) 8 lt. | \varnothing 205xh:355 | ■ Polished SS
 27509 | (304) 12 lt. | \varnothing 245xh:355 | ■ Polished SS



WASTE BIN OPEN

27116	(430) 5 lt.	∅ 210x260 mm	■ Polished SS
27117	(430) 8 lt.	∅ 210x320 mm	■ Polished SS
27109	(430) 11 lt.	∅ 250x320 mm	■ Polished SS



Rotating Cap



WASTE BIN

27115	(430) 5 lt.	∅ 210x260 mm	■ Polished SS
27102	(430) 8 lt.	∅ 210x320 mm	■ Polished SS
27103	(430) 11 lt.	∅ 250x320 mm	■ Polished SS



WASTE BIN OPEN

28521	(304) 3 lt.	∅186xh:320	■ Polished SS
28522	(304) 5 lt.	∅211xh:270	■ Polished SS
28523	(304) 12 lt.	∅256xh:365	■ Polished SS



WASTE BIN OPEN

27877	∅230xh:300	■ Matte Black
-------	------------	---------------



WASTE BIN OPEN

27560	(304) 3 lt.	∅210xh:205	■ Polished SS
27561	(304) 5 lt.	∅210xh:240	■ Polished SS
27563	(304) 12 lt.	∅250xh:330	■ Polished SS



WASTE BIN OPEN

27569	(304) 3 lt.	∅210xh:195	■ Polished SS
27570	(304) 5 lt.	∅210xh:240	■ Polished SS
27572	(304) 12 lt.	∅250xh:330	■ Polished SS



WASTE BIN OPEN

479420	Mesh	∅240xh:280	■ Matte Black
--------	------	------------	---------------



WASTE BIN OPEN

27876	Punched	∅230xh:300	■ Matte Black
-------	---------	------------	---------------



6 Lt.



4 Lt.



WASTE BIN

28846 Double $\varnothing 260 \times h: 290$ ■ Matte Black
28848 Triple $\varnothing 260 \times h: 290$ ■ Matte Black



WASTE BIN

28843 $\varnothing 205 \times h: 280$ ■ Polished SS
28844 $\varnothing 205 \times h: 280$ ■ Matte Black



WASTE BIN
27643 | 11 lt | 270xh:290 | Chrome



WASTE BIN (leather cover)
28636 | 3 lt | ø186xh:320 | Special Colour
28637 | 5 lt | ø186xh:320 | Special Colour



WASTE BIN (leather cover)
190030 | 3 lt | ø210xh:260 | Special Colour



WASTE BIN (leather cover)
28839 | 235x325x300 | Special Colour
28840 | 235x325x300 | Special Colour

28838 | Conical Inner Bucket
28841 | Inner Hanger Bucket
28842 | Sticker



WASTE BIN (leather cover)
190024 | ø210xh:260 | Special Colour



WASTE BIN (leather cover)
28638 | ø210xh:300 | Special Colour

Liquid Soap Types



SOAP DISPENSER, PHOTOCELL 700 ml
502840 | ■ Matte Stainless Steel



SOAP DISPENSER, PHOTOCELL 700 ml
502640 | ■ Matte Black

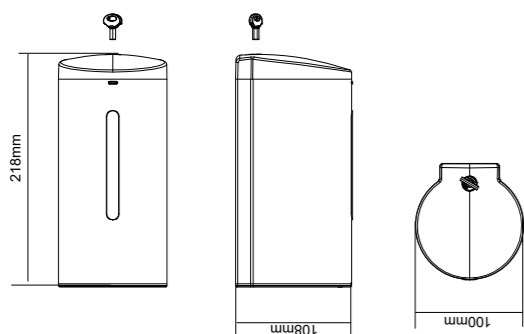

- > Works with 4 AA batteries.
- > 5 stage liquid soap setting.
- > Optional power adapter.
- > The distance between the counter and the dispenser during the installation phase must be at least 15 cm.



SOAP DISPENSER, PHOTOCELL 700 ml
502440 | ■ Gold



SOAP DISPENSER, PHOTOCELL 700 ml
502842 | ■ Matte Stainless Steel



SOAP DISPENSER, PHOTOCCELL 1100 ml
502844 | Matte Stainless Steel

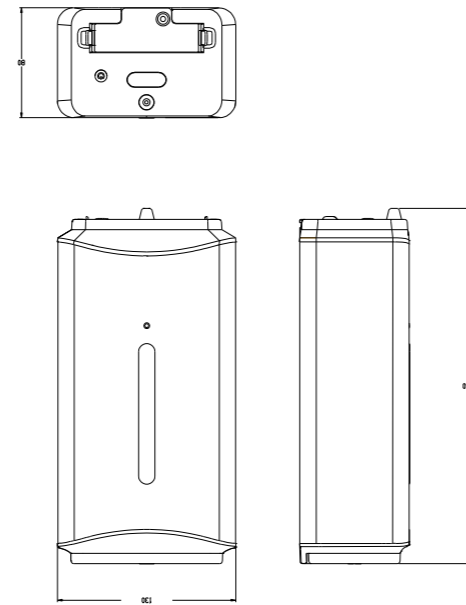

- > Works with 4 AA batteries.
- > 5 stage liquid soap setting.
- > Optional power adapter.
- > The distance between the counter and the dispenser during the installation phase must be at least 15 cm.



SOAP DISPENSER, PHOTOCCELL 1100 ml
502845 | Matte Black



SOAP DISPENSER, PHOTOCCELL 1100 ml
502444 | Gold

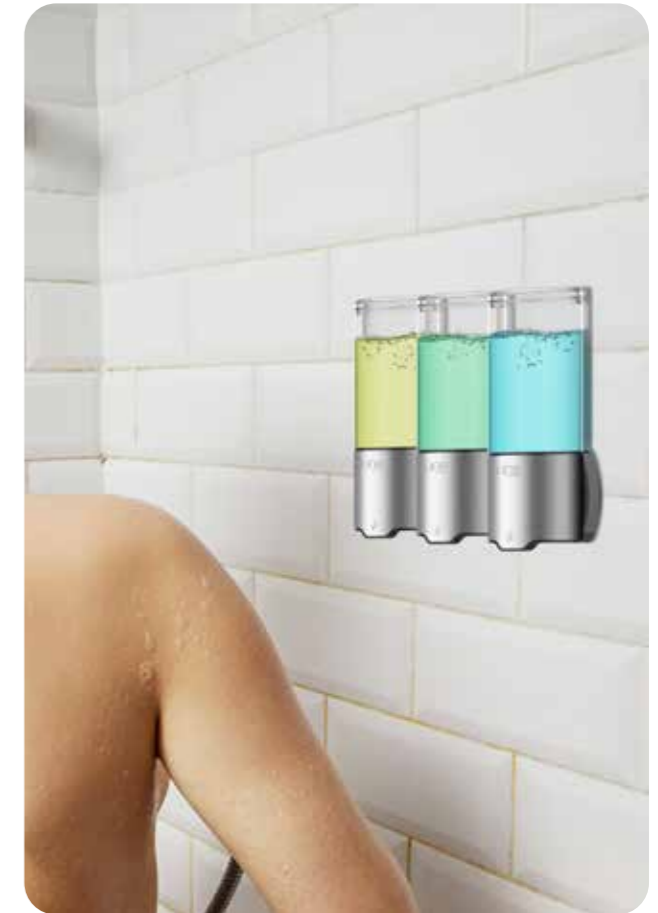

 Photocell

SOAP DISPENSER, PHOTOCCELL 900 ml
502940 | ■ ABS/Gray

- › Works with 4 AA batteries.
- › 5 stage liquid soap setting.
- › Optional power adapter.
- › The distance between the counter and the dispenser during the installation phase must be at least 15 cm.

 Photocell

SOAP DISPENSER, PHOTOCCELL 500 ml

501843	Single	■ Matte Stainless Steel
501845	Double	■ Matte Stainless Steel
501847	Triple	■ Matte Stainless Steel

- › Works with 4 AA batteries.
- › 5 stage liquid soap setting.
- › Optional power adapter.
- › The distance between the counter and the dispenser during the installation phase must be at least 15 cm.



 Photocell



Suitable for countertop bowl sinks.

SOAP DISPENSERS DECK MOUNTED 1000 ml

34148	Soap	■ Chrome
34162	Foam	■ Chrome

 Photocell



Suitable for countertop bowl sinks.

SOAP DISPENSERS DECK MOUNTED 1000 ml

34149	Soap	■ Chrome
34161	Foam	■ Chrome

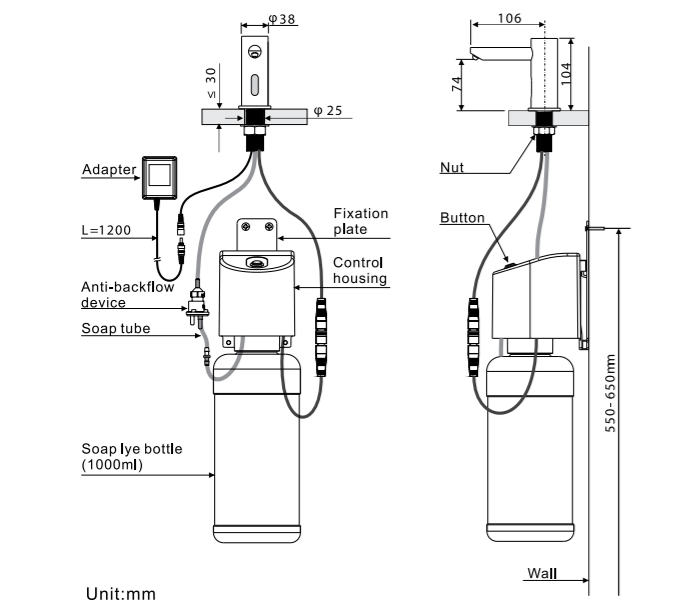



 Photocell



SOAP DISPENSERS DECK MOUNTED 1000 ml

34152 | ■ Chrome

 Photocell



SOAP DISPENSERS WALL MOUNTED 1000 ml

34153 | ■ Chrome

Unit: mm

 Photocell



SENSOR FAUCET AND SOAP DISPENSER 3000 ml

401142 | ■ Chrome

Unit: mm



SOAP DISPENSER

34745	1000 ml	■ Chrome
34746	1000 ml	■ Matte Stainless Steel
34747	500 ml	■ Chrome



SOAP DISPENSER, 1000 ml

34742	1000 ml	■ Chrome
-------	---------	----------



SOAP DISPENSER, 200 ml

34560	Table Top 200 ml	■ Chrome
34559	Wall Mounted 200 ml	■ Chrome
34565	Table Top 400 ml	■ Chrome
34566	Wall Mounted 400 ml	■ Chrome



SOAP DISPENSER, 200 ml

34660	Table Top 200 ml	■ Matte Black
34659	Wall Mounted 200 ml	■ Matte Black
34665	Table Top 400 ml	■ Matte Black
34666	Wall Mounted 400 ml	■ Matte Black



SOAP DISPENSER, 1000 ml

34145	1000 ml	■ Chrome
-------	---------	----------



Suitable for countertop bowl sinks.

SOAP DISPENSER, 1000 ml

34146	1000 ml	■ Chrome
-------	---------	----------



SOAP DISPENSER, 450 ml

34545	■ Chrome
-------	----------



SOAP DISPENSER, 450x2 ml

34546	■ Chrome
-------	----------



Foam



SOAP DISPENSER, 1000 ml

34147	1000 ml	■ Chrome
-------	---------	----------



SOAP DISPENSER, 1000 ml

34741	1000 ml	■ Chrome
-------	---------	----------



SOAP DISPENSER, 450x3 ml

34544	■ Chrome
-------	----------



Liquid Soap Types



SOAP DISPENSER
34521 500 ml Brass Pump ■ Matte Stainless Steel
34518 1000 ml Brass Pump ■ Matte Stainless Steel



SOAP DISPENSER, 1000 ml
34523 ■ Matte Stainless Steel



SOAP DISPENSER
34506 Table Top ■ Polished SS
34508 Wall Mounted ■ Polished SS



SOAP DISPENSER
34510 Table Top ■ Polished SS



SOAP DISPENSER 1000 ml
34524 ■ Matte Stainless Steel
34525 ■ Polished SS



> Suitable for Liquid Soap, Baticon and Disinfectant.

SOAP DISPENSER, 800 ml
34777 ABS/Aluminum



SOAP DISPENSER
34515 ■ Polished SS



SOAP DISPENSER
34505 Table Top ■ Polished SS
34507 Wall Mounted ■ Polished SS



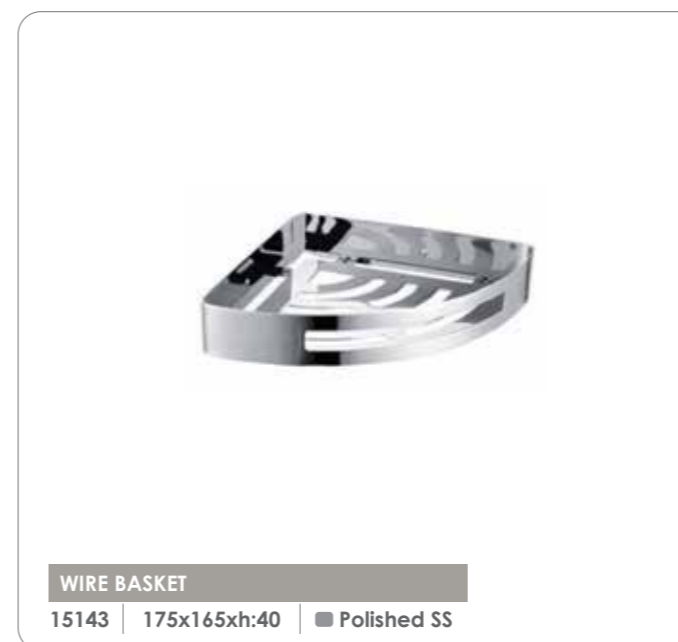

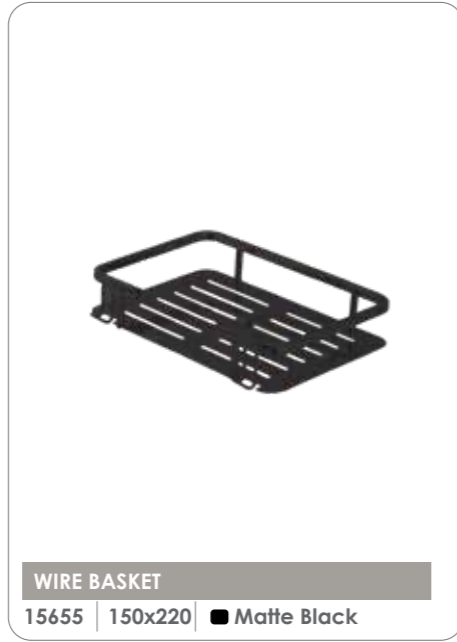



WIRE BASKET
16173 | 200x200xh:70 | ■ Polished SS



WIRE BASKET
16673 | 200x200xh:70 | ■ Matte Black



WIRE BASKET
16473 | 200x200xh:70 | ■ Gold



WIRE BASKET
16183 | 200x200xh:70 | ■ Polished SS



WIRE BASKET
16683 | 200x200xh:70 | ■ Matte Black



WIRE BASKET
16483 | 200x200xh:70 | ■ Gold



WIRE BASKET
16193 | 200x200xh:70 | ■ Polished SS



WIRE BASKET
16693 | 200x200xh:70 | ■ Matte Black



WIRE BASKET
16493 | 200x200xh:70 | ■ Gold

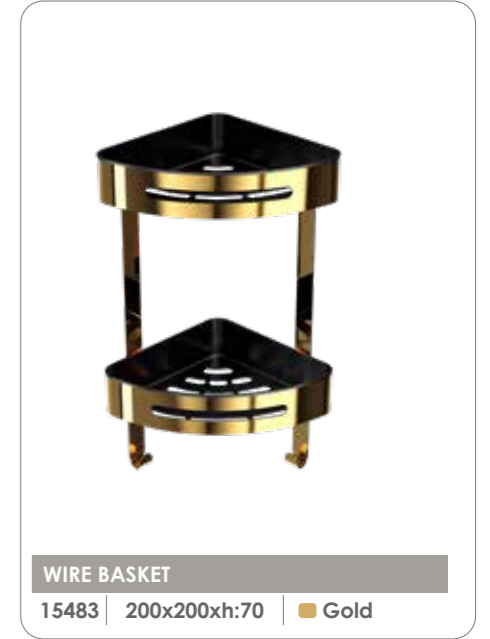
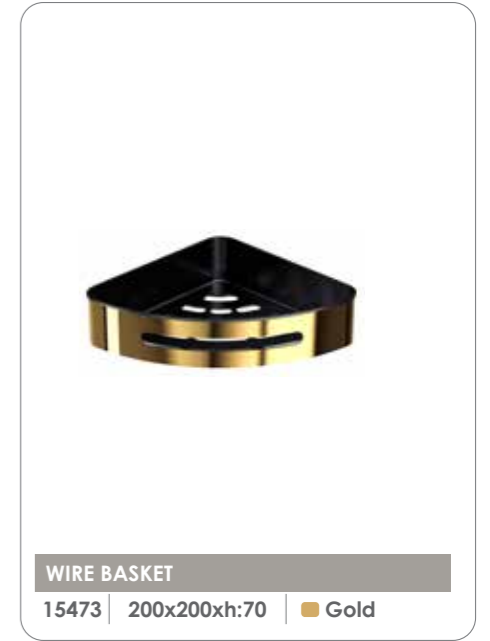
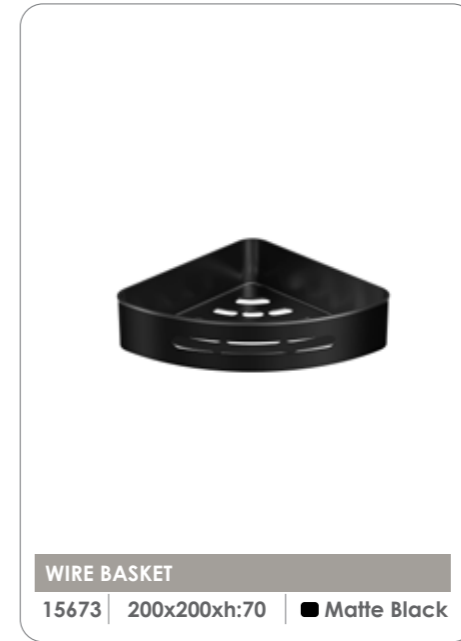



WIRE BASKET
15115 | 180x180 | ■ Chrome
15116 | 220x220 | ■ Chrome



WIRE BASKET
15616 | 180x180 | ■ Matte Black



WIRE BASKET
15141 | 125x80h:45 | ■ Chrome



WIRE BASKET
15102 | 180x180 | ■ Chrome
15103 | 220x220 | ■ Chrome



WIRE BASKET
15119 | 180x180 | ■ Chrome
15120 | 220x220 | ■ Chrome



WIRE BASKET
15619 | 180x180 | ■ Matte Black



WIRE BASKET
15105 | 180x180 | ■ Chrome
15106 | 220x220 | ■ Chrome

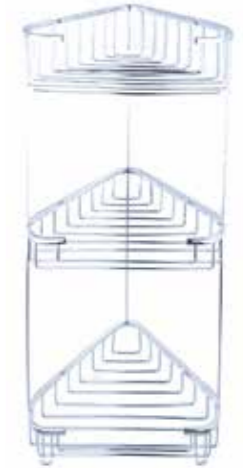

WIRE BASKET
15108 | 180x180 | ■ Chrome
15147 | 220x220 | ■ Chrome



WIRE BASKET
15123 | 180x180 | ■ Chrome
15124 | 220x220 | ■ Chrome



WIRE BASKET
15623 | 180x180 | ■ Matte Black



WIRE BASKET
15137 | 180x180 | ■ Chrome



WIRE BASKET
15251 | 180x180 | ■ Chrome



Led light



MAGNIFYING MIRRORS 3X
506101 | Chrome



MAGNIFYING MIRRORS 3X
506115 | Chrome

Led Işıklı



MAGNIFYING MIRRORS 3X
506102 | Chrome
506602 | Matte Black
506402 | Gold

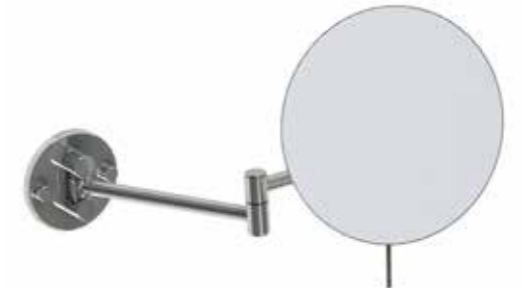

MAGNIFYING MIRRORS 3X
506114 | Chrome

Led Işıklı



MAGNIFYING MIRRORS 3X, Table Top
506120 | Siyah

Led Işıklı



MAGNIFYING MIRRORS 3X, Table Top
506121 | Chrome

Magnifying Mirrors



MAGNIFYING MIRRORS 2X
506104 | Chrome



MAGNIFYING MIRRORS 3X
506110 | Chrome



MAGNIFYING MIRRORS 2X
506111 | Chrome



MAGNIFYING MIRRORS 2X
506105 | Chrome



MAGNIFYING MIRRORS 3X, Table top
506112 | Chrome



MAGNIFYING MIRRORS 3X, Table Top
506113 | Chrome



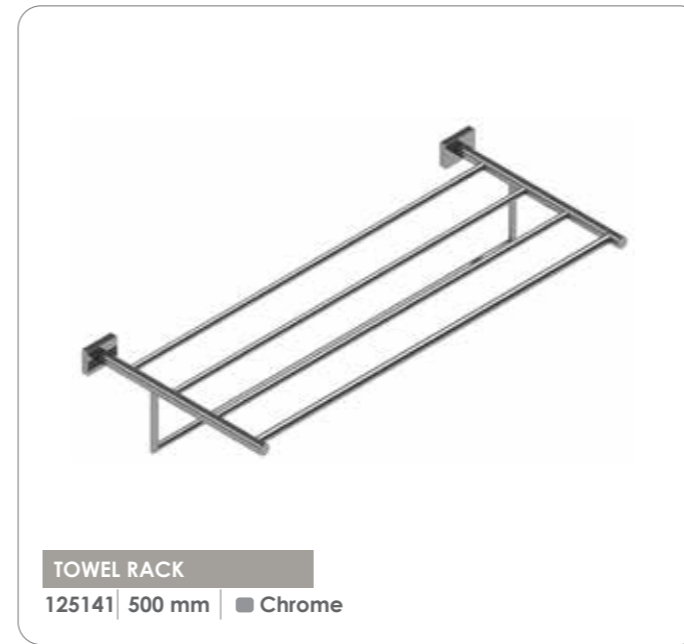

Towel Rack

Clothes Line

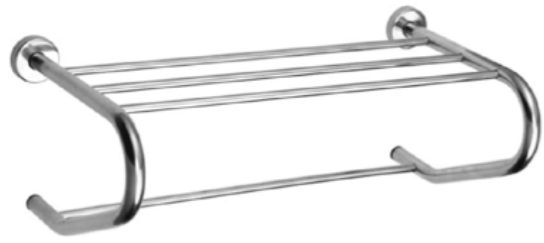

TOWEL RACK 500 mm
17102 ■ Chrome
17110 ■ Polished SS



TOWEL RACK 500 mm
17103 ■ Chrome
17107 ■ Polished SS



TOWEL RACK 500 mm
17235 ■ Polished SS



TOWEL RACK 500 mm
17108 | Triple | ■ Polished SS



TOWEL RING 500 mm
17112 | Quadruple | ■ Polished SS
17212 | Triple | ■ Polished SS



EXTENSIBLE CLOTH LINE 2500 mm
38538 | ■ Polished SS



TOWEL RING 500 mm
17115 | ■ Polished SS



TOWEL RING 500 mm
17114 | ■ Polished SS



TOWEL RING
17345 | 550 mm | □ Aluminum White
17346 | 750 mm | □ Aluminum White





KLEENEX BOX
39117 | 304 | Polished SS



KLEENEX BOX
39617 | 304 P. Steel | Matte Black



KLEENEX BOX
39417 | 304 P. Steel | Gold



KLEENEX BOX
39817 | 304 P. Steel | Rose



KLEENEX BOX
39709 | ABS Chrome



KLEENEX BOX
39008 | ABS Matte Black



KLEENEX BOX
39103 | 304 | Polished SS



KLEENEX BOX
39603 | 304 P. Steel | Matte Black



KLEENEX BOX
39403 | 304 P. Steel | Gold



KLEENEX BOX
39803 | 304 P. Steel | Rose



KLEENEX BOX
39702 | ABS Chrome



KLEENEX BOX
39602 | ABS Matte Black

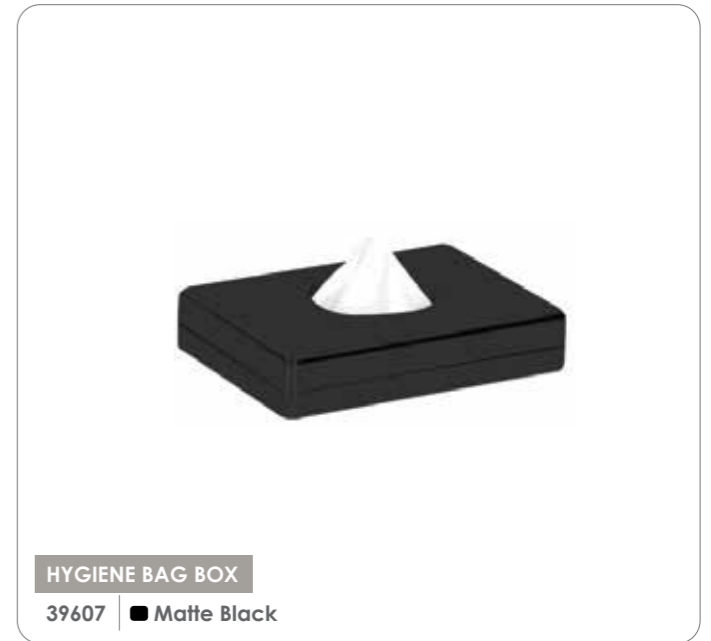
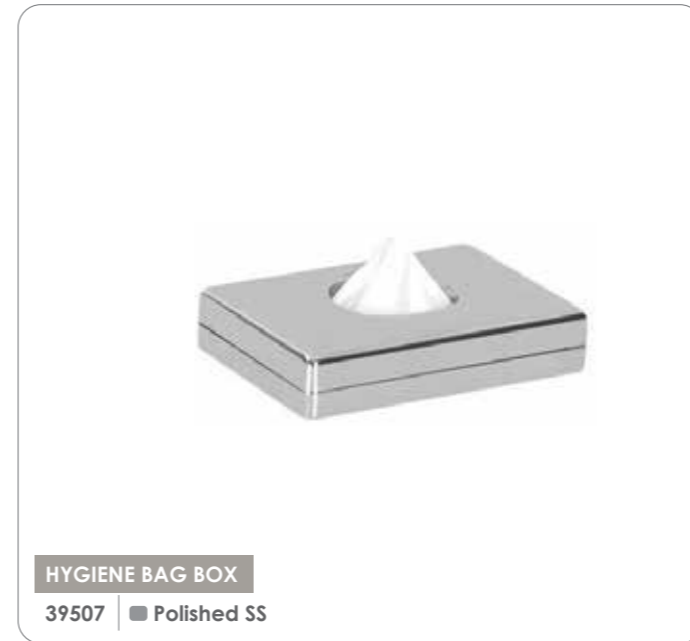
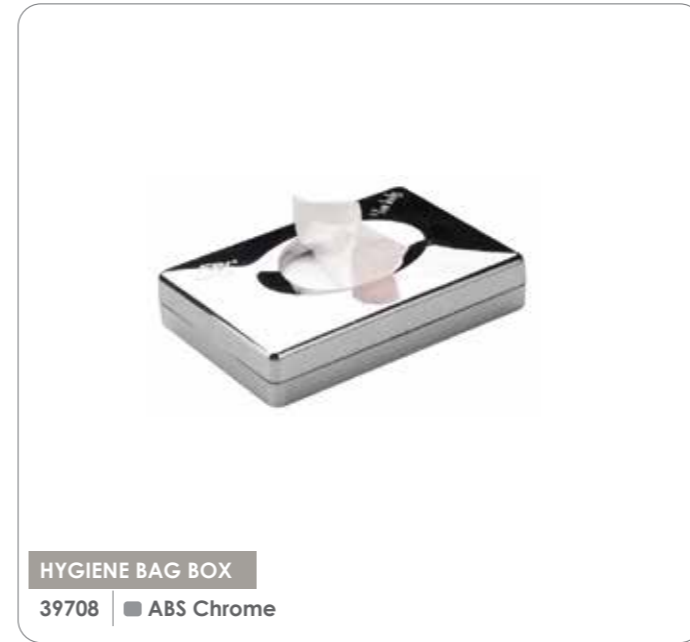

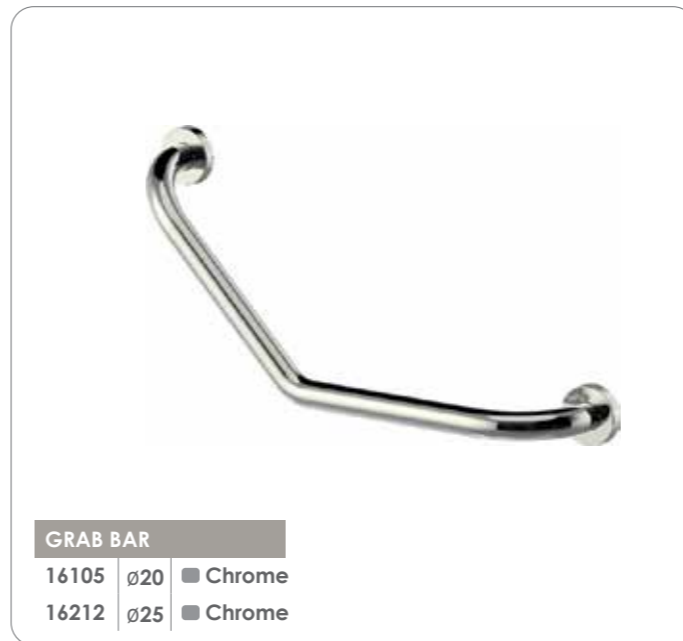
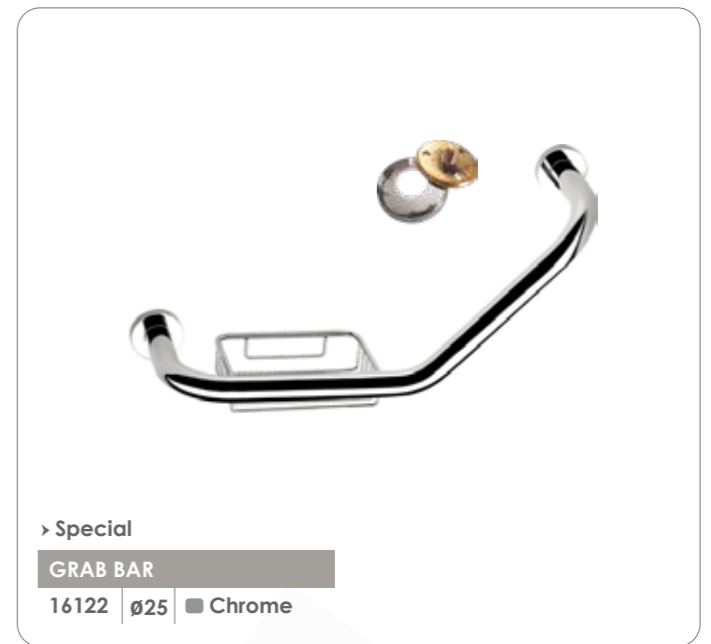

The background of the image is a light-colored, marbled pattern with soft, flowing veins in shades of grey and white, resembling natural stone or marble.

Hotel Equipment



HAIR DRYER 1400 W

8221195 White
8221201 Black



HAIR DRYER 1400 W

8221197 White
8221203 Black



HAIR DRYER /BRITTONY 1600 W

8221181 White
8221183 Black



HAIR DRYER /BRITTONY 1600 W

8221186 White
8221189 Black



HAIR DRYER /ALTEO 1875 W

8221175 White
8221178 Black



HAIR DRYER /ALTEO 1875 W

8221176 White
8221179 Black



HAIR DRYER /BRITTONY 1600 W
8221046 White
8221047 Black

HAIR DRYER /ALTEO 1875 W
8221043 White
8221044 Black

HAIR DRYER /LINEO 1600 W
8221329 White
8221330 Black

HAIR DRYER /Auva1400
8222251 Aluminum

HAIR DRYER, Hanger
866952 Chrome

HAIR DRYER, Hanger
866951 Chrome



HAIR DRYER 1800~2200 W
8221213 | w. Line Socket | White



HAIR DRYER 1800~2200
8221211 White
8221212 Black



HAIR DRYER 1350 W
8221214 | w. Line Socket | White



HAIR DRYER 1800~2200
8221219 White
8221220 Black



HAIR DRYER 1350 W
375144 | White



HAIR DRYER 1350 W
8221225 | White

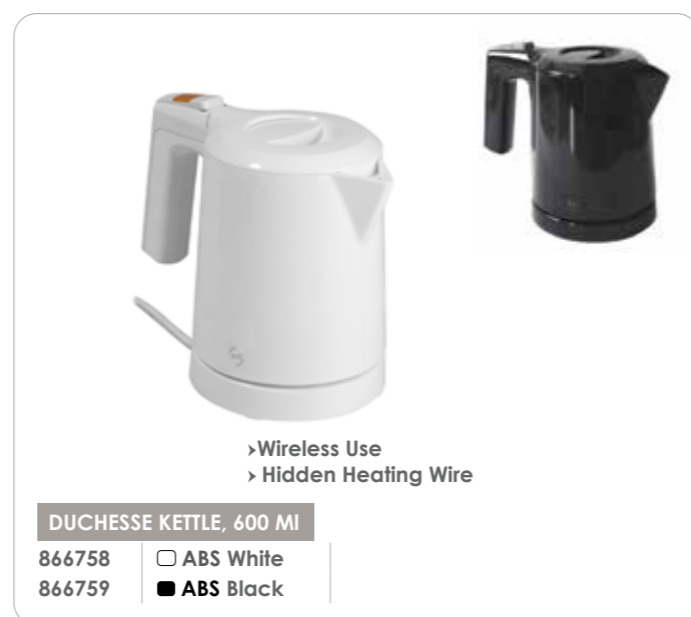
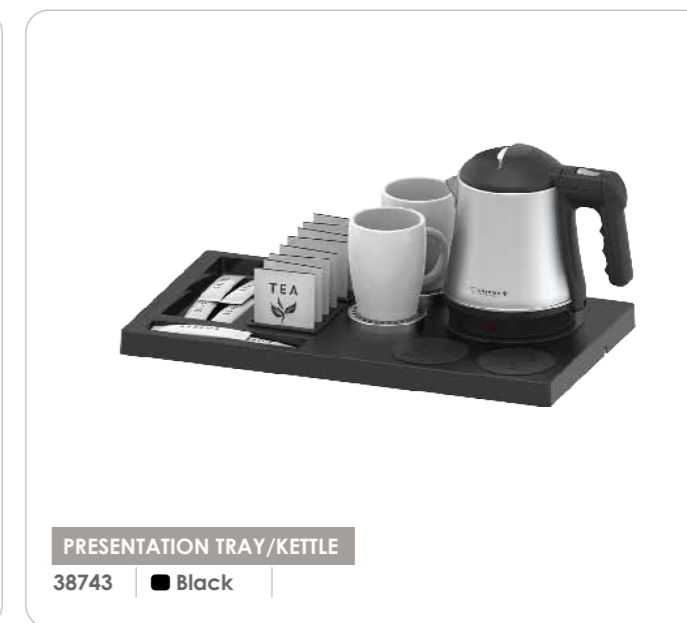
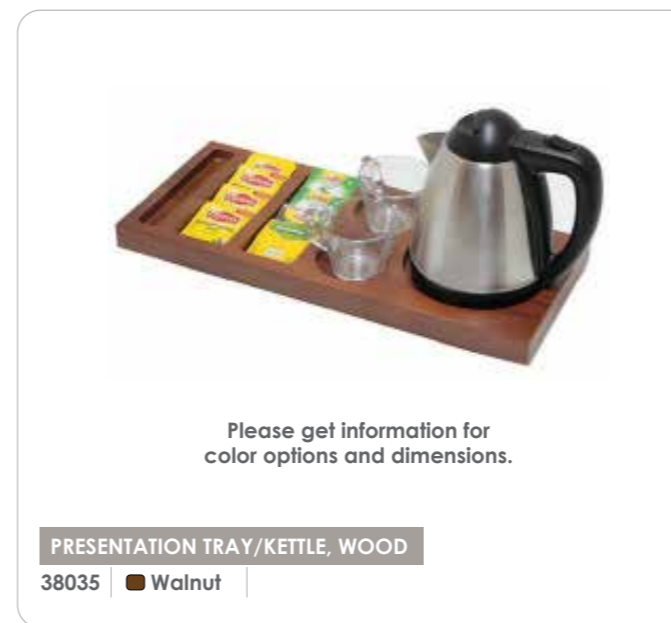

Coffee Machine



> Capsule System.
 > 850 ml water tank.
 > Suitable for nespresso capsules.

Coffee Machine / Corseto 1100
8661612 | Black

Electronic Safe



- > Works with 3 - 6 digit code.
- > 6 Digit Display.
- > Low battery status.
- > Illuminated Silicon keypad.
- > Auto-lock motor.
- > Automatic Interior Lighting.
- > Double sliding steel lock.
- > Emergency key (mechanical). Master (N-1) or Special (I-1)
- > Recording capacity: 105
- > Can be used with hand terminal: Opening and programming functions.
- > Master Code
- > External Battery Input.
- > Optional: Computer software and BAC

ELECTRONIC SAFES
 38568 250x350x250 White
 38558 250x350x250 Black
 38569 200x450x330 White
 38559 200x450x330 Black

- > Locking and unlocking with 3-6 digit customer code.
- > Opening with 6 digit master code.
- > Battery runs out, it can be opened by external intervention with emergency opening device (CEU) or mechanical pass key.
- > Shows battery level on digital screen.
- > 15 min. self-blocking after 4 wrong passwords.
- > Blocking time can be set as 15, 30, 45, 60 minutes.
- > Low battery consumption with servo motor.
- > Works with 4 1.5 V alkaline AA batteries.
- > The safe can be used for a fee with magnetic permission key. [Optional]
- > Laptop ebatında kasa içine konulan priz ve kablo bağlantısı [Opsiyonel]
- > Motion sensor lighting inside the safe. [Optional]
- > Long-lasting and durable electrostatic paint and color options.
- > Hidden hinge system.
- > Nickel-plated bolt system.
- > Installation from inside the case with strong dowels.

ELECTRONIC SAFES
 38583 225x400x435 White
 38584 225x400x435 Black
 38585 225x400x470 White
 38586 225x400x470 Black



THERMO ELECTRIC SYSTEM

- › Cooling capacity 40 Lt
- › Dimensions H545xW403xD436 mm
- › Working Range (Outdoor) +16 / +32 C
- › Cooling Range +5 / +7 C (25°C Room Temperature)
- › Cooling gas R600A
- › Energy Consumption 0.26 Kwh / 24h
- › Noise Level 0 dB
- › Net Weight 16 kg
- › Tempered glass shelf
- › Interior Lighting with sensor
- › Automatic Defrost
- › Interchangeable Door Direction
- › White and Black Color Options
- › Standard Lock System
- › 2 years Warranty
- › Made in France

MINIBAR 40 lt.

8661357 White
8661353 Black

MINIBAR GLASS COVER 40 lt.

8661358 White
8661354 Black



THERMO ELECTRIC SYSTEM

- › Cooling capacity 30 Lt
- › Dimensions H525xW381xD446 mm
- › Working Range (Outdoor) +16 / +32 C
- › Cooling Range +10/+13C(25°C Room Temperature)
- › Cooling gas R600A
- › Energy Consumption 0.26 Kwh / 24h
- › Noise Level 0 dB
- › Net Weight 16 kg
- › Tempered Glass Shelf
- › Interior Lighting with sensor
- › Automatic Defrost
- › Interchangeable Door Direction
- › White and Black Color Options
- › Standard Lock System
- › 2 years Warranty
- › Made in France

MINIBAR 30 lt.

8661355 White
8661351 Black

MINIBAR GLASS COVER 30 lt.

8661356 White
8661352 Black



ABSORBED SYSTEM

Cooling Type	Absorbed system
Cooler	nh3
Cooling Capacity	30 lt
Working Range	+4/+8
Voltage(Volt/hz)	220-240/50-60v/hz
Energy Consumption	1.05
Height	528 mm
Width	404 mm
Depth	420 mm
Weight	15 kg.
Warranty	2 Year
Made	Türkiye

Mini Bar 30 Lt

38555	Block Door	<input type="checkbox"/> White
38554	Glass Door	<input type="checkbox"/> White



ABSORBED SYSTEM

Cooling Type	Absorbed system
Cooler	nh3
Cooling Capacity	40 lt
Working Range	+4/+8
Voltage(Volt/hz)	220-240/50-60v/hz
Energy Consumption	1.05
Height	567
Width	436
Depth	432
Weight	13.5
Warranty	2 Year
Made	Türkiye

Mini Bar 40 Lt

38766	Block Door	<input checked="" type="checkbox"/> Black
38767	Glass Door	<input checked="" type="checkbox"/> Black



ABSORBED SYSTEM

Cooling Type	Absorbed system
Cooler	nh3
Cooling Capacity	30 lt
Working Range	+4/+8
Voltage(Volt/hz)	220-240/50-60v/hz
Energy Consumption	1.05
Height	528 mm
Width	404 mm
Depth	420 mm
Weight	15 kg.
Warranty	2 Year
Made	Türkiye

Mini Bar 30 Lt

38764	Block Door	<input checked="" type="checkbox"/> Black
38765	Glass Door	<input checked="" type="checkbox"/> Black



Mini Bar 40 Lt

38557	Block Door	<input type="checkbox"/> White
38556	Glass Door	<input type="checkbox"/> White

Folding Luggage Rack For Room



Ironing Table And Vacuum Cleaner

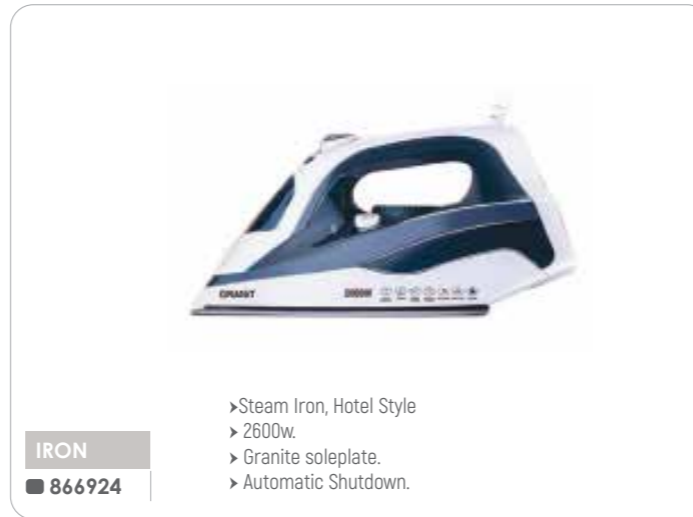
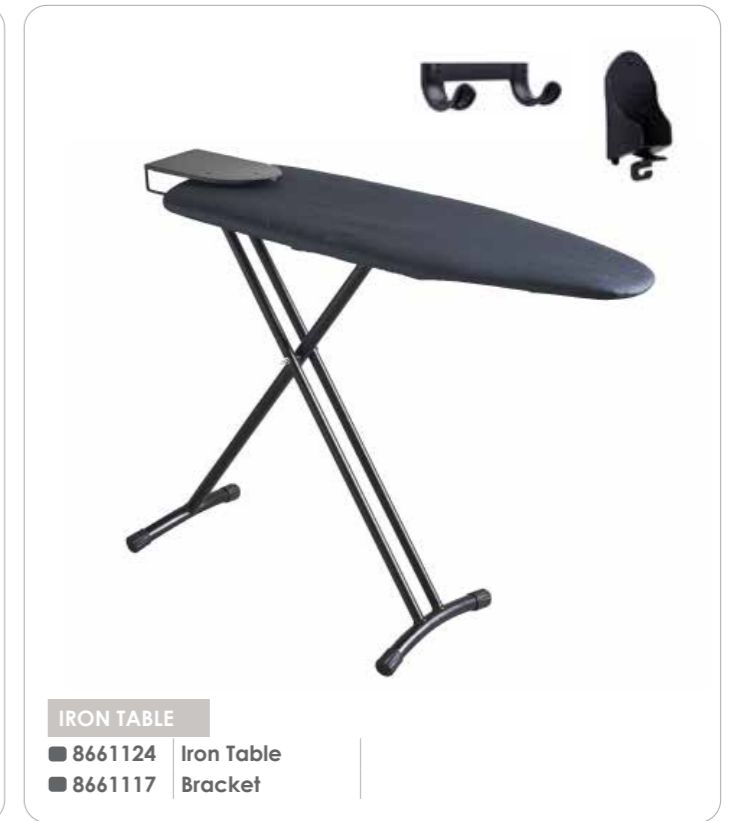



- › Electrostatic painted DKP frame.
- › Mdf-lam Body.
- › 5 compartment upper shelf.
- › Foldable side arms.
- › Impact protection rubber stopper.
- › Total 4 wheels, 2 of them with brakes.
- › Dimensions: 550x900x1450 /1300 mm

WOODEN CLEANING TROLLEY

■ 38027



- › Electrostatic painted DKP frame.
- › Mdf-lam body.
- › 5 compartment upper shelf.
- › Foldable side arms.
- › Lockable door.
- › Impact protection rubber stopper.
- › Total 4 wheels, 2 of them with brakes.
- › Dimensions: 550x900x1450 /1300 mm

WOODEN CLEANING TROLLEY

■ 38028



CLEANING TROLLEY

■ 38728

- › Electrostatic painted DKP frame.
- › Mdf-lam body.
- › 270° açılabilen kilitlenebilir kapılar.
- › Impact protection rubber stopper.
- › Total 4 wheels, 2 of them with brakes.
- › Dimensions: 600x950x1300 mm

MINI BAR TROLLEY

■ 38825



Cleaning Trolley

- > Carpeted surface.
- > Impact protection rubber stopper.
- > Iron chassis.
- > Total 4 wheels, 2 of them with brakes.
- > Dimensions: 650x1050x1910 mm



LUGGAGE TROLLEY

- 38218 ■ Matte Stainless Steel
- 38219 ■ Gold

- > Foldable body.
- > Carpeted surface.
- > 2 pieces of air wheels.
- > Dimensions: 400x650x1200 mm



LUGGAGE TROLLEY

- 38824 ■ Matte Stainless Steel
- 38822 ■ Painted



CLEANING TROLLEY

- 38725

Shoe Polishing Machine And Barriers



SHOE POLISHING MACHINE / SMALL

- 38105 | 370x210x330 mm



SHOE POLISHING MACHINE / LARGE

- 38108 | 550x340x910 mm

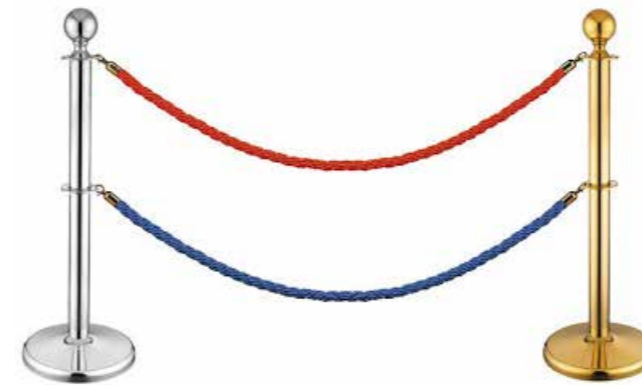

BARRIERS

- 38102 Chrome
- 38098 Gold
- 38099 Rope



BARRIERS

- 38101 Chrome
- 38103 Painted



TELEPHONE, ROOM
38738 ■ Black



TELEPHONE, BATHROOM
38736 ■ Black



SCALE
8661146



CIGARETTE ASHTRAY
38751 | ø70x100mm ■ Matte Stainless Steel



HANGER WITH HOOK
38752 Skirt clip
38753



HANGER WITH HOOK
38754 Skirt clip
38755





SHELF/COUNTER BOX
■ 941006



NOTEPAD BOX
■ 941012 | 105x160mm



DESK PAD
■ 941014

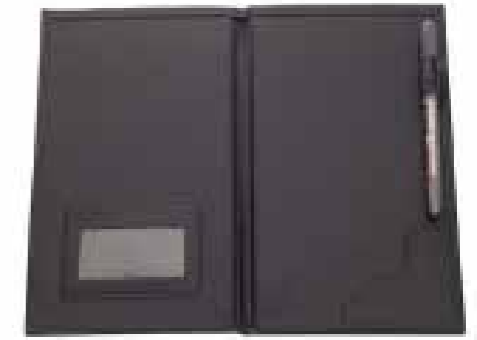

RECKONING COVER
■ 941001



BROCHURE HOLDER
■ 941005



COSMETIC BAG
■ 941009



TABLE MAT
■ 941002



COASTER
■ 941003 | 100x100 mm



SCREW MENU COVER
■ 941010
■ 941030 Ekstra Yaprak



MENU COVER
■ 941011



COASTER
■ 941004 | ø90 mm

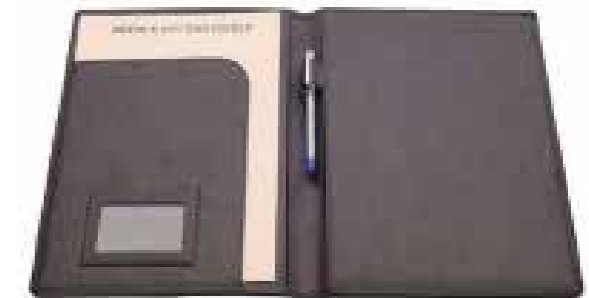

DESK PAD
■ 941013



TV REMOTE COVER
941022



PHONE & NOTE PAD
941018 | 150x210 mm



LUGGAGE TAG
941023 | 90x70 mm



BOTTLE COVER
941016



BARRACKS BAG
941017



DESK PAD, MEETING - FLAT
941020 | 320x420 mm



DESK PAD, MEETING - SLEEVE
941021 | 320x420 mm



NOTEPAD, ROOM
941015 | 350x300 mm



NOTEPAD, MEETING
941019 | 210x297 mm



- › Antibacterial
- › Anti-allergic
- › Heat Resistant
- › Complies with the WHO and the International Hoteliers Association standards.

The background of the slide is a light-colored marble pattern with soft, greyish veins. The text is centered on the right side of the slide.

General Use Equipment

Towels & Waste Bin Combination Units



- › 304 stainless steel photocell roll paper dispenser and waste bin combination.
- › 4x1, 5DC battery or Electric.
- › Adjustable paper size, 200, 250, 300mm.
- › 21cm towel support.
- › One key for paper dispenser and waste bin.
- › Dimensions 1300x370x160 (225)mm.
- › 23L detachable waste bin.
- › Weight: 12,2kg

TOWELS & WASTE COMBINATION UNITS, Photocell

23501	Flush	■ Matte Stainless Steel
23502	Surface	■ Matte Stainless Steel



- › 304 stainless steel photocell roll paper dispenser and waste bin combination.
- › 4x1, 5DC battery or Electric.
- › Adjustable paper size, 200, 250, 300mm.
- › 21cm towel support.
- › One key for paper dispenser and waste bin.
- › Dimensions 1300x320x130 (225)mm
- › 23L detachable waste bin.
- › Weight: 12,2kg

TOWELS & WASTE COMBINATION UNITS, Photocell

23531	Flush	■ Matte Stainless Steel
23532	Surface	■ Matte Stainless Steel

Towels & Waste Bin Combination Units



- › 304 stainless steel photocell paper dispenser and waste bin combination.
- › 4x1, 5DC battery or Electric.
- › Adjustable paper size, 200, 250, 300mm.
- › 2500W Hand dryer.
- › 23L detachable waste bin.
- › Dimensions: 1650x370x160 (225)mm.
- › Built-in 1600x320*150mm.
- › Weight: 21,5kg.

TOWELS & WASTE COMBINATION UNITS, Photocell

23503	Flush	■ Matte Stainless Steel
235039	Surface	■ Matte Stainless Steel



- › 304 stainless steel.
- › 800 pieces Z / 600 pieces C type folded paper dispenser.
- › 2500W Hand dryer.
- › 23L detachable waste bin.
- › Dimensions: 1650x370x160mm.
- › Built-in: 1600x320*150mm.
- › Weight: 21,5kg.

TOWELS & WASTE COMBINATION UNITS

23504	Flush	■ Matte Stainless Steel
235049	Surface	■ Matte Stainless Steel



- › 304 stainless steel.
- › 800 pieces Z / 600 pieces C type folded paper dispenser.
- › One key for paper dispenser and waste bin.
- › Dimensions: 1300x370x160mm.
- › Built-in: 1250x320x150mm
- › 23L detachable waste bin.
- › Weight: 11,5kg.

TOWELS & WASTE COMBINATION UNITS

23507	Flush	■ Matte Stainless Steel
235079	Surface	■ Matte Stainless Steel



- › 304 stainless steel.
- › 300-400 paper dispenser.
- › The lower compartment is a waste bin.
- › The door has a locking mechanism.
- › Dimensions : 330x130x1400mm.
- › Built-in : 290x120x1360mm.

TOWELS & WASTE COMBINATION UNITS

23511	Flush	■ Matte Stainless Steel
235119	Surface	■ Matte Stainless Steel

Towels & Waste Bin Combination Units

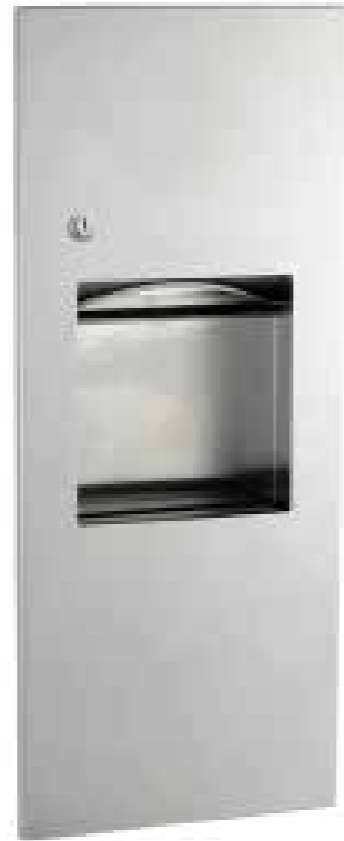

- › 304 matte stainless steel.
- › 200-300 paper dispenser.
- › The lower compartment is a waste bin.
- › The door has a locking mechanism.
- › Dimensions : 330x130x790mm

TOWELS & WASTE COMBINATION UNITS

23512	Flush	■ Matte Stainless Steel
235129	Surface	■ Matte Stainless Steel



- › 304 matte stainless steel.
- › 200-300 paper dispenser.
- › The lower compartment is a waste bin.
- › The door has a locking mechanism.
- › Dimensions : 350x120x710mm

TOWELS & WASTE COMBINATION UNITS

23560	Flush	■ Matte Stainless Steel
235609	Surface	■ Matte Stainless Steel



- › 304 matte stainless steel.
- › 200-300 paper dispenser.
- › The lower compartment is a waste bin.
- › The door has a locking mechanism.
- › Dimensions : 330x130x790mm

TOWELS & WASTE COMBINATION UNITS

23612	Flush	■ Matte Black
236129	Surface	■ Matte Black



- › 400 Z type folded paper dispenser.
- › Dimensions: 1050x260x100mm

TOWELS & WASTE COMBINATION UNITS

23619	430 Quality	■ Matte Stainless Steel
23520	304 Quality	■ Matte Stainless Steel



TOWELS DISPENSER, Photocell
22507 Surface ■ Matte Stainless Steel
225079 Flush ■ Matte Stainless Steel



TOWELS DISPENSER, Photocell
22607 Surface ■ Matte Black



ABS TOWELS DISPENSER, Photocell
22708 ■ Blue



ABS TOWELS DISPENSER, Photocell
22709 ■ Honey



TOWELS DISPENSER, Photocell
25507 Surface ■ Matte Stainless Steel
255079 Flush ■ Matte Stainless Steel



TOWELS DISPENSER, Photocell
25607 Surface ■ Matte Black



ABS TOWELS DISPENSER, Photocell
22710 ■ Blue



ABS TOWELS DISPENSER, Photocell
22711 ■ Smoke



TOWELS DISPENSER		
22506	400 Paper	■ Matte Stainless Steel
22605	400 Paper	■ Matte Stainless Steel
22306	400 Paper	■ Polished Stainless Steel

TOWELS DISPENSER		
22502	200 Paper	■ Matte Stainless Steel
22601	200 Paper	■ Matte Stainless Steel
22302	200 Paper	■ Polished Stainless Steel

TOWELS DISPENSER		
22606	400 Paper	■ Matte Black

TOWELS DISPENSER		
22602	200 Paper	■ Matte Black



TOWELS DISPENSER
22514 400 Paper ■ Matte Stainless Steel



TOWELS DISPENSER
22614 400 Paper ■ Matte Black



TOWELS DISPENSER, Flush
22516 400 Paper ■ Matte Stainless Steel





- › Jet Engine.
- › 12 sn. Drying time.
- › Summer Mode 500 w
- › Winter Mode 1000 w
- › Engine Life 300.000 Av.

HAND DRYER

36255 | ■ Matte Stainless Steel



- › Jet Engine.
- › 12 sn. Drying time.
- › Summer Mode 500 w
- › Winter Mode 1000 w
- › Engine Life 300.000 Av.

HAND DRYER

36655 | ■ Matte Black



› Hepa Filter life 70.000



- › Jet Engine.
- › 10 sn. Drying time.
- › Summer Mode 300 w
- › Winter Mode 830 w
- › Engine Life 1.000.000 Av.

HAND DRYER

36280

› 13 sn. Drying time.

HAND DRYER 2500 W

36250 | ■ Matte Stainless Steel



- › Jet Engine.
- › 12 sn. Drying time.
- › Summer Mode 400 w
- › Winter Mode 800 w
- › Engine Life 300.000 Av.

HAND DRYER

36265 | ■ Matte Stainless Steel



- › Jet Engine.
- › 12 sn. Drying time.
- › Summer Mode 400 w
- › Winter Mode 800 w
- › Engine Life 300.000 Av.

HAND DRYER

36665 | ■ Matte Black



› Hepa Filtre Ömrü 70.000



- › Jet Engine.
- › 10 sn. Drying time.
- › Summer Mode 300 w
- › Winter Mode 830 w
- › Engine Life 1.000.000 Av.

HAND DRYER

36267 | ■ ABS Black



- › Jet Engine.
- › 5-10 sn. Drying time.

HAND DRYER 1330 W

36271 | ■ ABS Grey

Paper Holders

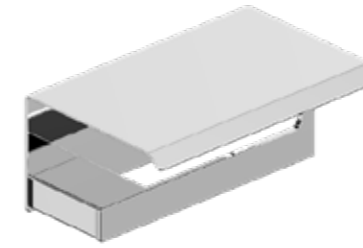

Toilet Paper Holder, Shelf
127115 | Chrome

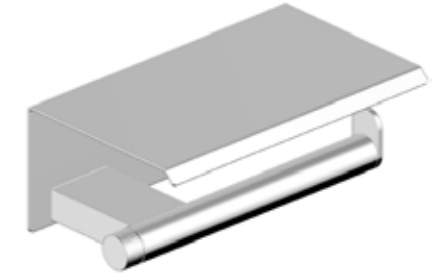

Toilet Paper Holder, Shelf
119115 | Chrome



Toilet Paper Holder, Shelf
21527 | Chrome



Toilet Paper Holder - Double, Shelf
21529 | Chrome



Toilet Paper Holder, Shelf
21627 | Matte Black



Toilet Paper Holder - Double, Shelf
21629 | Matte Black





Toilet Paper Holder
21607 Surface 430 ■ Matte Stainless Steel
21508 Surface 304 ■ Matte Stainless Steel



Toilet Paper Holder
21610 Flush 430 ■ Matte Stainless Steel
21511 Flush 304 ■ Matte Stainless Steel



Toilet Paper Holder, Stingy, Lockable
21501 Ø 220 mm ■ Matte Stainless Steel



Toilet Paper Holder, Stingy, Lockable
21500 Ø 220 mm ■ Matte Black

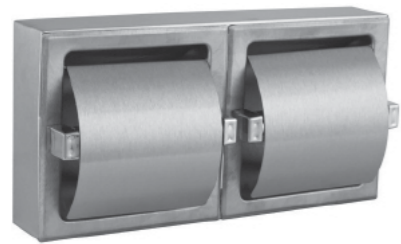

Toilet Paper Holder, Double
21608 Surface 430 ■ Matte Stainless Steel
21509 Surface 304 ■ Matte Stainless Steel



Toilet Paper Holder, Double
21612 Flush 430 ■ Matte Stainless Steel
21513 Flush 304 ■ Matte Stainless Steel



Toilet Paper Holder, Roll, Lockable
21602 Ø 220 mm 430 ■ Matte Stainless Steel
21503 Ø 220 mm 304 ■ Matte Stainless Steel
21604 Ø 280 mm 430 ■ Matte Stainless Steel
21505 Ø 280 mm 304 ■ Matte Stainless Steel



Toilet Paper Holder, Stingy, Lockable
21601 Ø 220 mm ■ Matte Black
21605 Ø 280 mm ■ Matte Black



SEAT-COVER DISPENSER
21518 | 304 | ■ Matte Stainless Steel
21617 | 430 | ■ Matte Stainless Steel



SEAT-COVER DISPENSER
21618 | ■ Matte Black



SEAT-COVER DISPENSER
21520 | Flush 304 | ■ Matte Stainless Steel



SEAT-COVER DISPENSER
21620 | Flush 304 | ■ Matte Black



► Suitable for all standard toilets.

TOILET SEAT SYSTEM, Photocell
38104 | □ ABS White



► 42 pieces in 1 box.
► 1 Roll is 90 Uses.



Toilet Seat Cover
38146



WASTE BIN, PEDAL

27501	(304) 20 lt.	Ø245xh:444	■ Polished Stainless Steel
27502	(304) 30 lt.	Ø315xh:355	■ Polished Stainless Steel
27503	(304) 45 lt.	Ø315xh:444	■ Polished Stainless Steel



Soft Cover

WASTE BIN, PEDAL

27614	(430) 16 lt.	Ø245xh:444	■ Polished Stainless Steel
27528	(430) 20 lt.	Ø315xh:355	■ Polished Stainless Steel
27529	(430) 30 lt.	Ø315xh:444	■ Polished Stainless Steel
27530	(430) 40 lt.	Ø315xh:630	■ Polished Stainless Steel

WASTE BIN, PEDAL

27605	(430) 16 lt.	Ø245xh:444	■ Polished Stainless Steel
27631	(430) 20 lt.	Ø315xh:355	■ Polished Stainless Steel
27632	(430) 30 lt.	Ø315xh:444	■ Polished Stainless Steel
27633	(430) 40 lt.	Ø315xh:630	■ Polished Stainless Steel



WASTE BIN, Rotating Cover

28670	(430) 15 lt.	∅ 240x300 mm	■ Matte Stainless Steel
28671	(430) 25 lt.	∅ 240x600 mm	■ Matte Stainless Steel
28672	(430) 38 lt.	∅ 300x650 mm	■ Matte Stainless Steel



WASTE BIN

28576	(430) 15 lt.	∅ 240x400 mm	■ Matte Stainless Steel
28577	(430) 38 lt.	∅ 300x650 mm	■ Matte Stainless Steel
28578	(430) 63 lt.	∅ 360x820 mm	■ Matte Stainless Steel



WASTE BIN

28673	(430) 15 lt.	∅ 240x300 mm	■ Matte Stainless Steel
28674	(430) 25 lt.	∅ 240x600 mm	■ Matte Stainless Steel
28675	(430) 38 lt.	∅ 300x650 mm	■ Matte Stainless Steel



WASTE BIN

285764	15 lt.	∅ 240x400 mm	■ Matte Black
285774	38 lt.	∅ 300x650 mm	■ Matte Black
285784	63 lt.	∅ 360x820 mm	■ Matte Black



Döner Kapaklı



WASTE BIN, Rotating Cover

28561 | (304) 30 lt. | Ø250xh:655 | ■ Polished Stainless Steel



WASTE BIN, Pedal

27519	304	40 lt.	Ø 400x400 mm	■ Polished Stainless Steel
27520	304	50 lt.	Ø 400x500 mm	■ Polished Stainless Steel
27521	304	70 lt.	Ø 400x600 mm	■ Polished Stainless Steel
27522	304	90 lt.	Ø 400x700 mm	■ Polished Stainless Steel



WASTE BIN, Open

27698 | (304) 30 lt. | 300x300x700 mm | ■ Matte Stainless Steel



WASTE BIN, Open

27699 | (304) 30 lt. | Ø 300x470 mm | ■ Matte Stainless Steel



WASTE BIN, Rotating Cover

27104	(430)	16 lt.	Ø 245x380 mm	■ Polished Stainless Steel
27105	(430)	20 lt.	Ø 245x465 mm	■ Polished Stainless Steel
27106	(430)	27 lt.	Ø 245x645 mm	■ Polished Stainless Steel
27107	(430)	32 lt.	Ø 315x465 mm	■ Polished Stainless Steel
27108	(430)	45 lt.	Ø 315x645 mm	■ Polished Stainless Steel



WASTE BIN

27110	(430)	16 lt.	Ø 245x380 mm	■ Polished Stainless Steel
27111	(430)	20 lt.	Ø 245x465 mm	■ Polished Stainless Steel
27112	(430)	27 lt.	Ø 245x645 mm	■ Polished Stainless Steel
27113	(430)	32 lt.	Ø 315x465 mm	■ Polished Stainless Steel
27114	(430)	45 lt.	Ø 315x645 mm	■ Polished Stainless Steel



WASTE BIN, Open

27700 | (304) 30 lt. | 300x300x475 mm | ■ Matte Stainless Steel

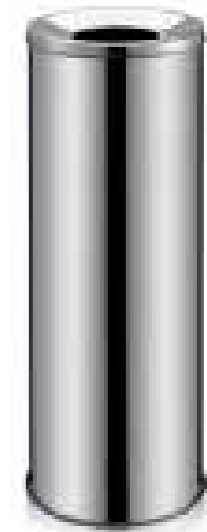

WASTE BIN, Open

276685 | (304) 45 lt. | Ø315x600 mm | ■ Matte Stainless Steel



WASTE BIN, Rotating Cover

27118	(304) 10 lt.	170x220x240 mm	■ Matte Stainless Steel
27120	(304) 16 lt.	170x220x400 mm	■ Matte Stainless Steel
27122	(304) 27 lt.	200x320x400 mm	■ Matte Stainless Steel
27124	(304) 32 lt.	200x320x500 mm	■ Matte Stainless Steel
27126	(304) 54 lt.	250x360x600 mm	■ Matte Stainless Steel
27128	(304) 84 lt.	300x400x700 mm	■ Matte Stainless Steel



WASTE BIN, Open

28118	(304) 10 lt.	170x220x240 mm	■ Matte Stainless Steel
28120	(304) 16 lt.	170x220x400 mm	■ Matte Stainless Steel
28122	(304) 27 lt.	200x320x400 mm	■ Matte Stainless Steel
28124	(304) 32 lt.	200x320x500 mm	■ Matte Stainless Steel
28126	(304) 54 lt.	250x360x600 mm	■ Matte Stainless Steel
28128	(304) 84 lt.	300x400x700 mm	■ Matte Stainless Steel



WASTE BIN, Open

27501	304 7 lt.	140x235x335 mm	■ Matte Stainless Steel
27502	304 11 lt.	155x245x430 mm	■ Matte Stainless Steel
27503	304 25 lt.	240x280x485 mm	■ Matte Stainless Steel
27504	304 36 lt.	240x280x645 mm	■ Matte Stainless Steel
27510	304 45 lt.	300x350x555 mm	■ Matte Stainless Steel



WASTE BIN, Rotating Cover

27594	304 7 lt.	150x170x285 mm	■ Matte Stainless Steel
27595	304 11 lt.	180x200x390 mm	■ Matte Stainless Steel
27596	304 16 lt.	180x200x500 mm	■ Matte Stainless Steel
27597	304 25 lt.	240x280x480 mm	■ Matte Stainless Steel
27598	304 36 lt.	240x280x635 mm	■ Matte Stainless Steel
27599	304 45 lt.	300x350x555 mm	■ Matte Stainless Steel
27100	304 54 lt.	300x350x615 mm	■ Matte Stainless Steel
27101	304 80 lt.	300x350x895 mm	■ Matte Stainless Steel



WASTE BIN, Open

27138	304 6 lt.	100x250x250 mm	■ Matte Stainless Steel
27140	304 11 lt.	120x250x360 mm	■ Matte Stainless Steel
27142	304 16 lt.	120x330x400 mm	■ Matte Stainless Steel
27144	304 25 lt.	155x360x435 mm	■ Matte Stainless Steel



Can be produced in special sizes.

WASTE BIN COVER

27527	■ Matte Stainless Steel
-------	-------------------------

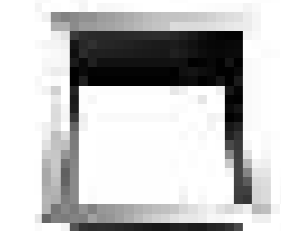

Can be produced in special sizes.

WASTE BIN COVER

27526	■ Matte Stainless Steel
-------	-------------------------



RECYCLE BINS

31512	2'li	350x660x800 mm	■ Matte Stainless Steel
31513	3'lü	350x900x800 mm	■ Matte Stainless Steel
31514	4'lü	350x1150x800 mm	■ Matte Stainless Steel



RECYCLE BINS

31612	2'li	350x660x800 mm	■ Matte Stainless Steel
31613	3'lü	350x900x800 mm	■ Matte Stainless Steel
31614	4'lü	350x1150x800 mm	■ Matte Stainless Steel



RECYCLE BINS

31712	2'li	300x680x800 mm	■ Matte Stainless Steel
31713	3'lü	300x820x800 mm	■ Matte Stainless Steel
31714	4'lü	300x1080x800 mm	■ Matte Stainless Steel



RECYCLE BINS

32712	2'li Döner Kapaklı	300x680x800 mm	■ Polished Stainless Steel
32713	3'lü Döner Kapaklı	300x820x800 mm	■ Polished Stainless Steel
32714	4'lü Döner Kapaklı	300x1080x800 mm	■ Polished Stainless Steel



RECYCLE BINS w/Stand

31822	3'lü Çemberli	1110x400x700 mm	■ Polished Stainless Steel
31823	4'lü Çemberli	1480x400x700 mm	■ Polished Stainless Steel
31832	3'lü Döner Kapaklı	1110x400x700 mm	■ Polished Stainless Steel
31833	4'lü Döner Kapaklı	1480x400x700 mm	■ Polished Stainless Steel



RECYCLE BINS w/Stand

31912	2'li Döner Kapaklı	360x640x670 mm	■ Colour
31913	3'lü Döner Kapaklı	360x940x670 mm	■ Colour
31914	4'lü Döner Kapaklı	360x1230x670 mm	■ Colour
31922	2'li Çemberli	360x690x690 mm	■ Colour
31923	3'lü Çemberli	360x1030x690 mm	■ Colour
31924	4'lü Çemberli	360x1360x690 mm	■ Colour

Waste Bins with Ashtray



WASTE BIN w/Ashtray
30510 | 300x470 mm | ■ Matte Stainless Steel



WASTE BIN w/Ashtray
30513 | 300x470 mm | ■ Matte Stainless Steel



WASTE BIN w/Ashtray
30509 | 340x340x780 mm | ■ Matte Stainless Steel



WASTE BIN w/Ashtray
30512 | 250x490 mm | ■ Matte Stainless Steel



WASTE BIN w/Ashtray, Wall Mount
30516 | 300x600 mm | ■ Matte Stainless Steel



ASHTRAY, Pole Type
30511 | 100x820 mm | ■ Matte Stainless Steel



WASTE BIN w/Ashtray
30517 | 300x400x490 mm | ■ Matte Stainless Steel



WASTE BIN w/Ashtray
30601 | ∅ 1900x600 mm | ■ Polished Stainless Steel
30602 | ∅ 2100x600 mm | ■ Polished Stainless Steel
30603 | ∅ 2500x600 mm | ■ Polished Stainless Steel
30604 | ∅ 2800x600 mm | ■ Polished Stainless Steel

Waste Bins with Ashtray



WASTE BIN w/Ashtray, Footed
29507 | ■ Polished Stainless Steel



WASTE BIN w/Ashtray, Footed
29508 | ■ Polished Stainless Steel



ASHTRAY
30606 | ■ Polished Stainless Steel
30406 | ■ Gold



ASHTRAY
30607 | ■ Polished Stainless Steel
30407 | ■ Gold



WASTE BIN w/Ashtray, Footed
29810 | ■ Colour



WASTE BIN w/Ashtray, Footed
29811 | ■ Colour



WASTE BIN w/Ashtray, Footed
29812 | ■ Colour



WASTE BIN w/Ashtray, Wood
29804 | □ Footed, Painted



WASTE BIN w/Ashtray, Wood
29802 | 360x650 mm | Colour

Umbrella Boxes



UMBRELLA BOX
31802 | ■ Painted



UMBRELLA BOX
31603 | ■ Polished Stainless Steel



UMBRELLA BOX
31204 | ■ Gold



UMBRELLA BOX
31205 | ■ Matte Stainless Steel
31203 | ■ Colour
31207 | ■ Nylon Bag 7000 pcs.

Flower Pots



POT
40519 | ∅ 300x300 mm | ■ Matte Stainless Steel
40521 | ∅ 400x400 mm | ■ Matte Stainless Steel
40524 | ∅ 600x600 mm | ■ Matte Stainless Steel



POT
40525 | 400x400x450 mm | ■ Matte Stainless Steel
40527 | 400x400x800 mm | ■ Matte Stainless Steel
40529 | 500x500x600 mm | ■ Matte Stainless Steel



POT
40510 | ∅ 300x270 mm | ■ Matte Stainless Steel
40512 | ∅ 400x360 mm | ■ Matte Stainless Steel
40514 | ∅ 500x450 mm | ■ Matte Stainless Steel



POT
40501 | ∅ 300x500 mm | ■ Stainless Steel
40503 | ∅ 400x800 mm | ■ Stainless Steel

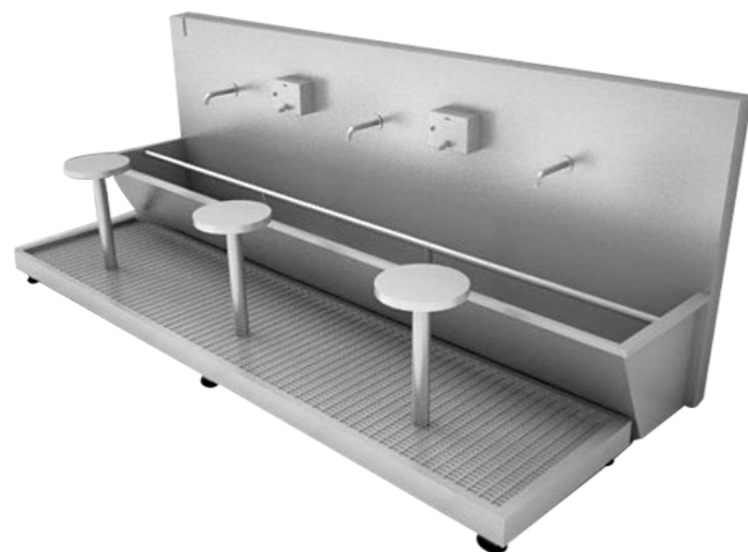

ABLUTION UNIT

- | | | |
|-------|-----------|-------------------------|
| 25521 | Double | ■ Matte Stainless Steel |
| 25523 | Triple | ■ Matte Stainless Steel |
| 25525 | Quadruple | ■ Matte Stainless Steel |

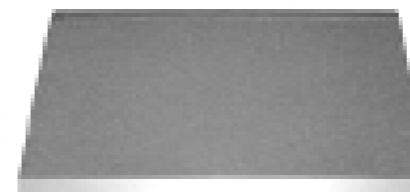

> Curly mat is included in the price.

MAT For HYGIENE

- | | | |
|-------|-------------|-------------------------|
| 25501 | 400x600 mm | ■ Matte Stainless Steel |
| 25502 | 900x600 mm | ■ Matte Stainless Steel |
| 25503 | 1200x600 mm | ■ Matte Stainless Steel |



HAND WASHING UNIT, Knee Control

- | | | |
|-------|----------------|-------------------------|
| 24502 | 500x500x410 mm | ■ Matte Stainless Steel |
|-------|----------------|-------------------------|

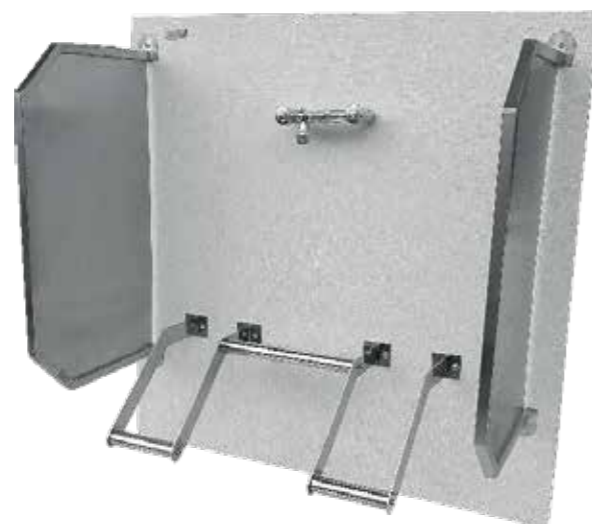

ABLUTION UNIT

- | | |
|-------|-------------------------|
| 25520 | ■ Matte Stainless Steel |
|-------|-------------------------|



MASK AND BONNET CABINET

- | | | |
|-------|--------------------|-------------------------|
| 24501 | Set 500x800x220 mm | ■ Matte Stainless Steel |
| 24301 | Üst Bölme | ■ Matte Stainless Steel |

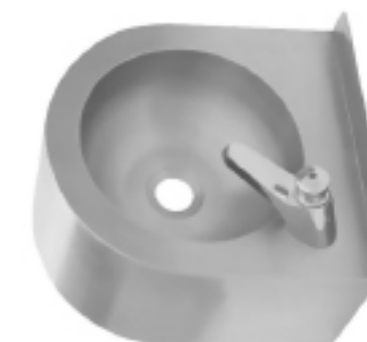

> Faucet not included.

HAND WASHING UNIT

- | | | |
|-------|----------------|-------------------------|
| 24503 | 410x410x270 mm | ■ Matte Stainless Steel |
|-------|----------------|-------------------------|



HAND WASHING UNIT, Triple

- | | |
|-------|-------------------------|
| 25519 | ■ Matte Stainless Steel |
|-------|-------------------------|



HAND WASHING UNIT, Double Sink

- | | |
|-------|-------------------------|
| 25513 | ■ Matte Stainless Steel |
|-------|-------------------------|



> Faucet not included.

MAT WASHING SINK

- | | | |
|-------|----------------|-------------------------|
| 25518 | 600x600x800 mm | ■ Matte Stainless Steel |
|-------|----------------|-------------------------|



MAT WASHING SINK

- | | | |
|-------|----------------|-------------------------|
| 21524 | 500x500x720 mm | ■ Matte Stainless Steel |
|-------|----------------|-------------------------|



WASING UNIT
25516 | ■ Matte Stainless Steel



EMERGENCY CART
25517 | ■ Matte Stainless Steel



UNIT
25531 | ■ Matte Stainless Steel



UNIT
25512 | ■ Matte Stainless Steel



WATER DISPENSER

25615	Tekli	■ Matte Stainless Steel
25625	Tekli Fotoselli	■ Matte Stainless Steel
25515	Çiftli	■ Matte Stainless Steel
25505	Çiftli Fotoselli	■ Matte Stainless Steel





BABY CARE UNIT
38106 | ABS Cream



BABY CARE UNIT
38110 | ABS Cream
38192 | ABS Grey

The background of the slide is a light-colored, marbled pattern with soft, greyish veins and swirls, resembling natural stone or marble. The overall tone is clean and professional.

DISABLED
AND
NEED OF CARE
EQUIPMENT

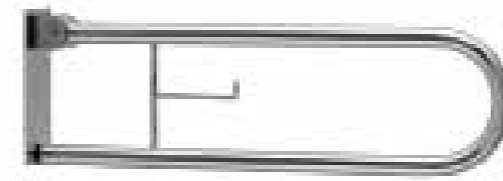

HANDLE, Paper Holder
20103 | 304 | ■ Matte Stainless Steel

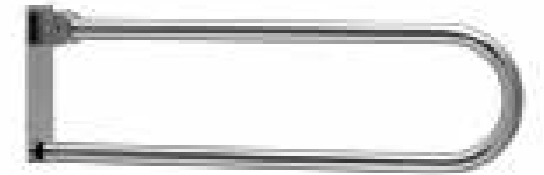

HANDLE
20102 | 304 | ■ Matte Stainless Steel

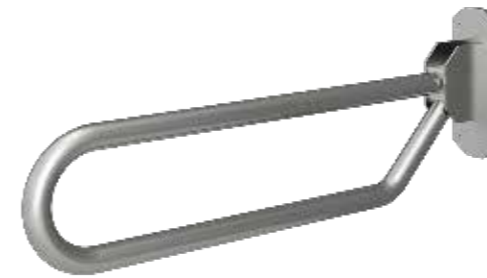

HANDLE
20129 | 304 | ■ Matte Stainless Steel



PAPER HOLDER for HANDLE
20130 | 304 | ■ Matte Stainless Steel



HANDLE, w Pole
20101 | 304 | ■ Matte Stainless Steel

Handles



HANDLE, Flat			
20104	304	300 mm	■ Matte Stainless Steel
20105	304	400 mm	■ Matte Stainless Steel
20106	304	500 mm	■ Matte Stainless Steel
20107	304	600 mm	■ Matte Stainless Steel
22104	304	300 mm	■ Polished Stainless Steel
22105	304	400 mm	■ Polished Stainless Steel
22106	304	500 mm	■ Polished Stainless Steel
22107	304	600 mm	■ Polished Stainless Steel



HANDLE, Angled		
20108	304	■ Matte Stainless Steel
22108	304	■ Polished Stainless Steel



HANDLE, Corner L Flat		
20109	304	■ Matte Stainless Steel
22109	304	■ Polished Stainless Steel



HANDLE, Corner L Angled		
20110	304	■ Matte Stainless Steel
22110	304	■ Polished Stainless Steel



HANDLE, Wall to Floor w Pole		
20114	304	■ Matte Stainless Steel
22114	304	■ Polished Stainless Steel



HANDLE, Wall to Floor		
20113	304	■ Matte Stainless Steel
22113	304	■ Polished Stainless Steel

Shower Seats



> Compact Table		
SHOWER SEAT, Foldable, 2 Foot		
20127	304	■ Matte Stainless Steel



> Compact Table		
SHOWER SEAT, Foldable		
20131	304	■ Matte Stainless Steel



SHOWER SEAT, Foldable, 2 Foot		
20126	304	■ Matte Stainless Steel



SHOWER SEAT, Foldable, 1 Foot		
20116	304	■ Matte Stainless Steel

Shower Seats

Mirrors



SHOWER SEAT, Foldable
20118 | ■ Matte Stainless Steel



> Compact Antibacterial
SHOWER SEAT, Foldable, 1 Foot
20115 | ■ Matte Stainless Steel



SHOWER SEAT, Foldable, 1 Foot, Tarpaulin
20125 | ■ Matte Stainless Steel



SHOWER SEAT, Foldable, 1 Foot
20124 | ■ Black



MIRROR, Adjustable hook
20119 | ■ Matte Stainless Steel



MIRROR, Adjustable hook
20111 | ■ Matte Stainless Steel



MIRROR, Adjustable hook 360°
20112 | ■ Matte Stainless Steel



MIRROR, Adjustable hook, Towel Shelf
22119 | ■ Polished Stainless Steel

The background of the image is a light-colored, marbled pattern with soft, flowing veins in shades of grey and white. The text is centered on the right side of the image.

Photocell Faucets



FAUCET, Single Inlet, Battery-Adapter
261501 | Chrome



FAUCET, Double Inlet, Battery-Adapter
261502 | Chrome



FAUCET with Liquid Soap, Table Top, 3000 ml
401142 | Chrome

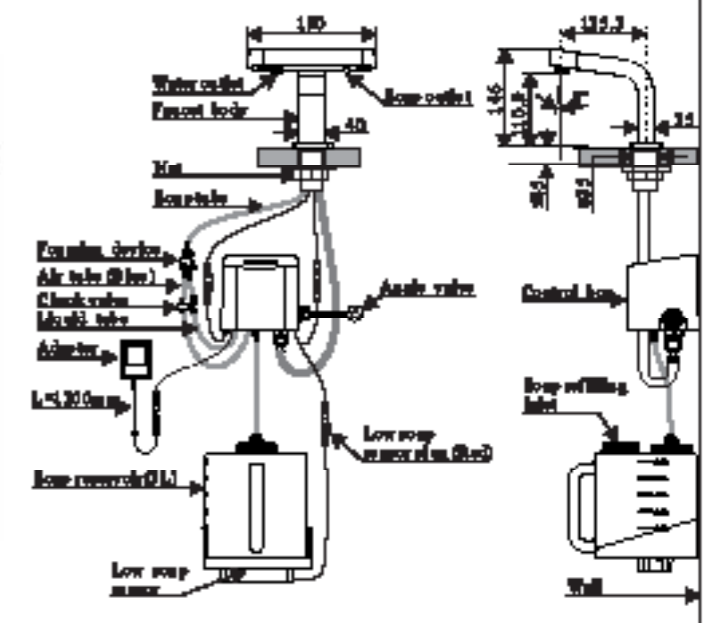

Unit: mm



FAUCET, Double Inlet, Battery-Adapter
261504 | Chrome



FAUCET, Single Inlet, Battery-Adapter
261506 | Chrome



FAUCET, Wall Mount, Single Inlet, Battery-Adapter
261507 | Chrome



FAUCET, Single Inlet, Battery-Adapter
261509 | Chrome



FAUCET, Single Inlet, Battery-Adapter
261508 | Chrome



FAUCET, High, Single Inlet, Battery-Adapter
261503 | Chrome



MIX, Hot and cool water mixer
261510 | Chrome



FAUCET, Disabled and Medical
27711 | Chrome

The background of the image is a light-colored, marbled pattern with soft, flowing veins in shades of grey and white, resembling natural stone or marble.

Beach, Pool
Showers



El duşlu seçeneği
Hand shower option

Sıcak - soğuk seçeneği
Hot-cold option

Ayak yıkama seçeneği
Foot wash option

KALİTE/
QUALITY

304 KALİTE	Ø 89 - 2010 mm
316 KALİTE	Ø 89 - 2010 mm

BOYUT/SIZE

BEACH POOL SHOWERS, Avangarde

26512	Hand Head	■ Matte Stainless Steel
26612	Hand Head	■ Matte Stainless Steel

> Fleksi 1/2

El duşlu seçeneği
Hand shower option

Sıcak - soğuk seçeneği
Hot-cold option

Ayak yıkama seçeneği
Foot wash option

KALİTE/
QUALITY

304 KALİTE	Ø 76 - 2300 mm
316 KALİTE	Ø 76 - 2300 mm

BOYUT/SIZE

BEACH POOL SHOWERS, Optima

26524	Hand Head	■ Matte Stainless Steel
26525	Hand Head	■ Matte Stainless Steel

> Fleksi 1/2

El duşlu seçeneği
Hand shower option

Sıcak - soğuk seçeneği
Hot-cold option

Ayak yıkama seçeneği
Foot wash option

> Fleksi 1/2

BEACH POOL SHOWERS, Olivia		
KALİTE/ QUALITY	BOYUT/SIZE	
304 KALİTE	Ø 76 - 2100 mm	
316 KALİTE	Ø 76 - 2100 mm	

26515	Top Head	■ Matte Stainless Steel
26615	Top, Hand Head	■ Matte Stainless Steel
26514	Hand Head	■ Matte Stainless Steel
26614	Hand Head	■ Matte Stainless Steel

El duşlu seçeneği
Hand shower option

Sıcak - soğuk seçeneği
Hot-cold option

> Fleksi 1/2

BEACH POOL SHOWERS, Elsa		
KALİTE/ QUALITY	BOYUT/SIZE	
304 KALİTE	Ø 51 - 2070 mm	
316 KALİTE	Ø 51 - 2070 mm	

26522	El Duşlu	■ Matte Stainless Steel
26523	El Duşlu	■ Matte Stainless Steel

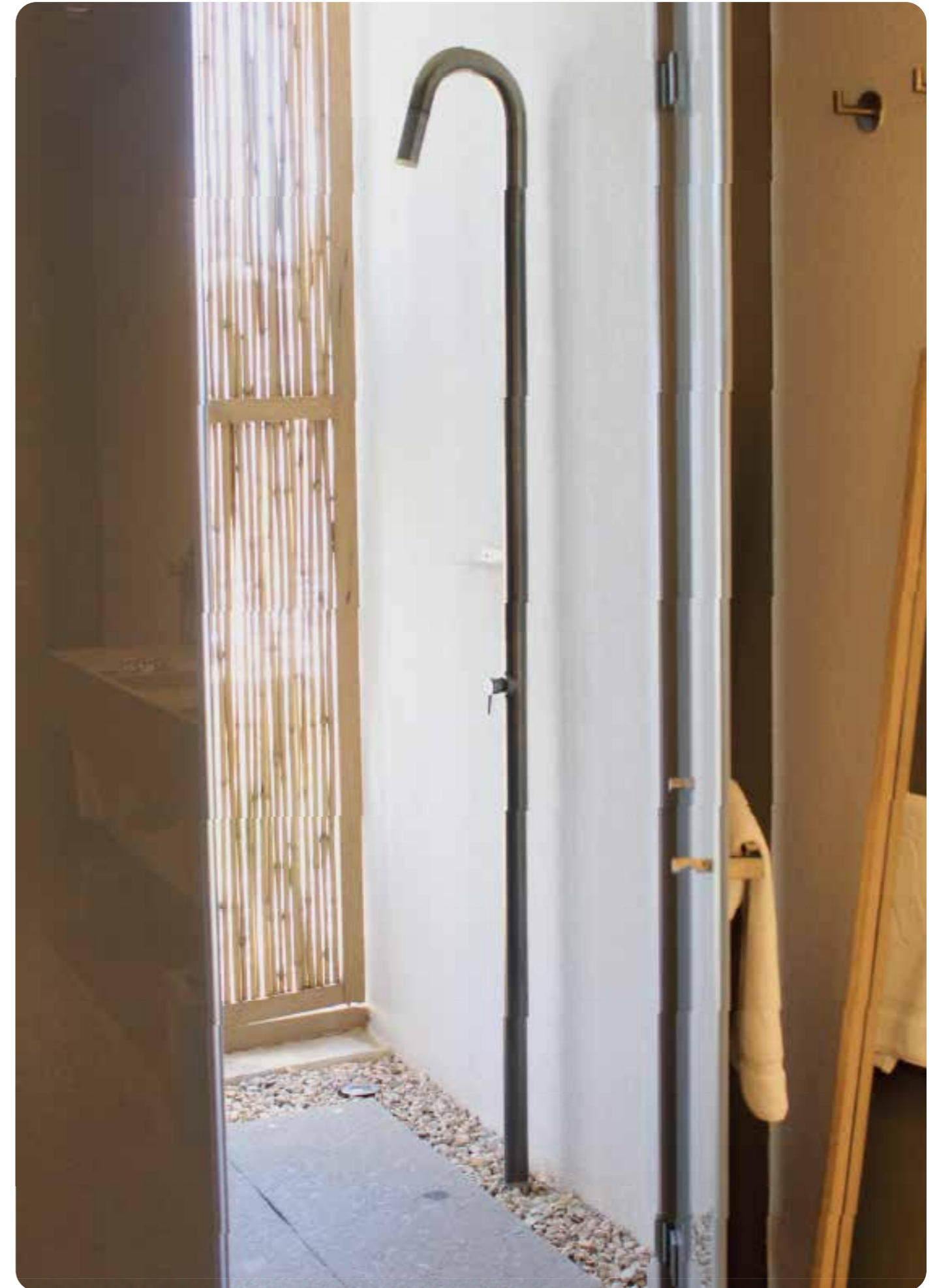



El duşlu seçeneği
Hand shower option

Sıcak - soğuk seçeneği
Hot-cold option

KALİTE/ QUALITY	BOYUT/SIZE
304 KALİTE	Ø 51 - 2100 mm
316 KALİTE	Ø 51 - 2100 mm

BEACH POOL SHOWERS, Marine

26511	■ Matte Stainless Steel
26611	Hand Head ■ Matte Stainless Steel

> Fleksi 1/2

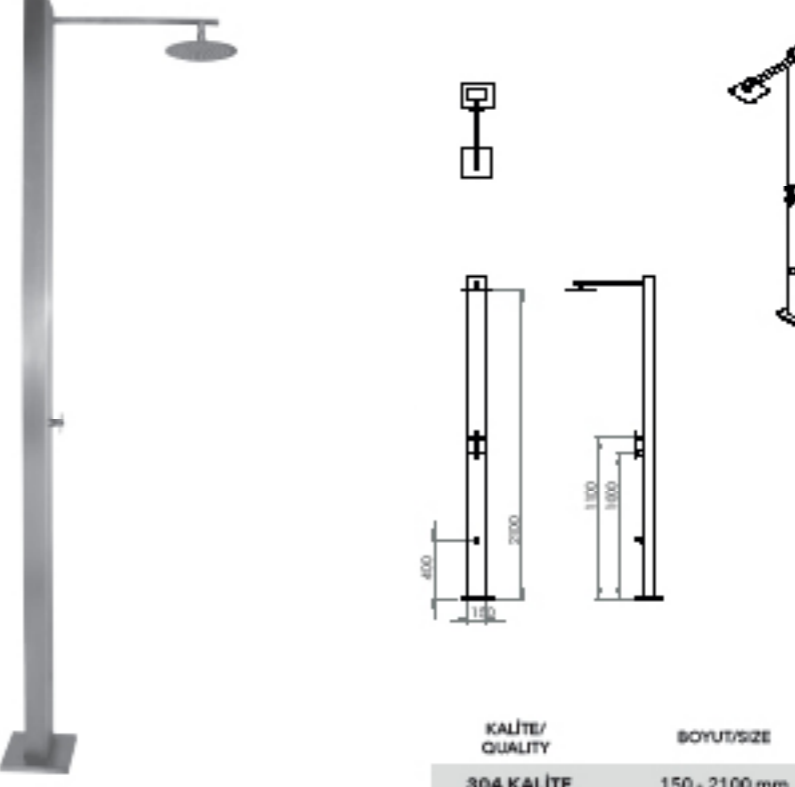

El duşlu seçeneği
Hand shower option

Sıcak - soğuk seçeneği
Hot-cold option

Ayak yıkama seçeneği
Foot wash option

KALİTE/ QUALITY	BOYUT/SIZE
304 KALİTE	150 - 2100 mm
316 KALİTE	150 - 2100 mm

BEACH POOL SHOWERS, Square

26533	■ Matte Stainless Steel
26633	Hand Head ■ Matte Stainless Steel

Beğlantı

> Fleksi 1/2

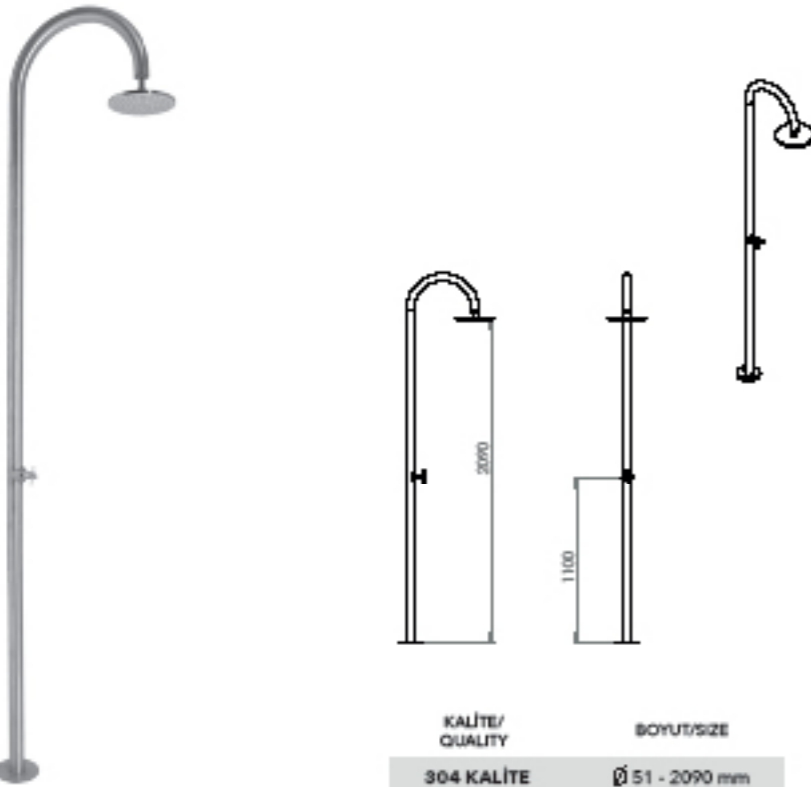

El duşlu seçeneği
Hand shower option

Sıcak - soğuk seçeneği
Hot-cold option

KALİTE/ QUALITY	BOYUT/SIZE
304 KALİTE	Ø 51 - 2090 mm
316 KALİTE	Ø 51 - 2090 mm

BEACH POOL SHOWERS, Simple

26501	■ Matte Stainless Steel
26503	Top Head ■ Matte Stainless Steel

> Fleksi 1/2

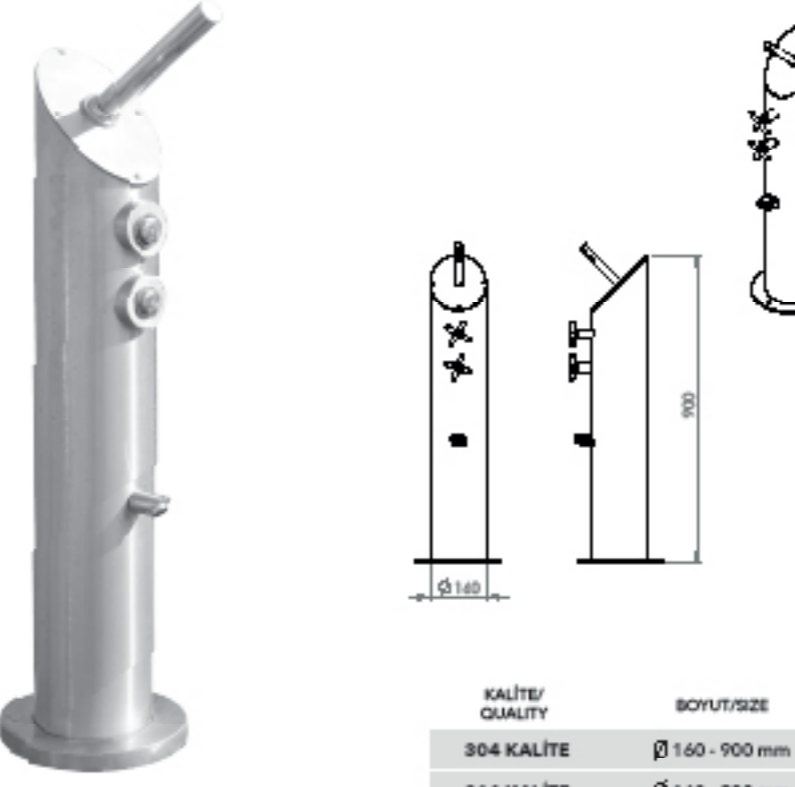

Ayak yıkama
Foot wash

El duşlu seçeneği
Hand shower option

Sıcak - soğuk seçeneği
Hot-cold option

Zaman ayarlı
Time setting option

KALİTE/ QUALITY	BOYUT/SIZE
304 KALİTE	Ø 160 - 900 mm
316 KALİTE	Ø 160 - 900 mm

SMALL FOOT WASH

26508	■ Matte Stainless Steel
-------	-------------------------

Beğlantı

> Fleksi 1/2



STAINLESS TOILETS
24507 | 360x580x350 mm | ■ Matte Stainless Steel



STAINLESS TOILETS
24506 | 390x580x355 mm | ■ Matte Stainless Steel



STAINLESS TOILETS
24505 | 670x580x390 mm | ■ Matte Stainless Steel



STAINLESS TOILETS
24508 | 690x430x257 mm | ■ Matte Stainless Steel



STAINLESS TOILETS
24509 | 582x492 mm | ■ Matte Stainless Steel



STAINLESS TOILETS
24504 | ■ Matte Stainless Steel



The background of the image is a light-colored, marbled pattern with soft, flowing veins in shades of grey and white, resembling natural stone or marble.

Economical Products

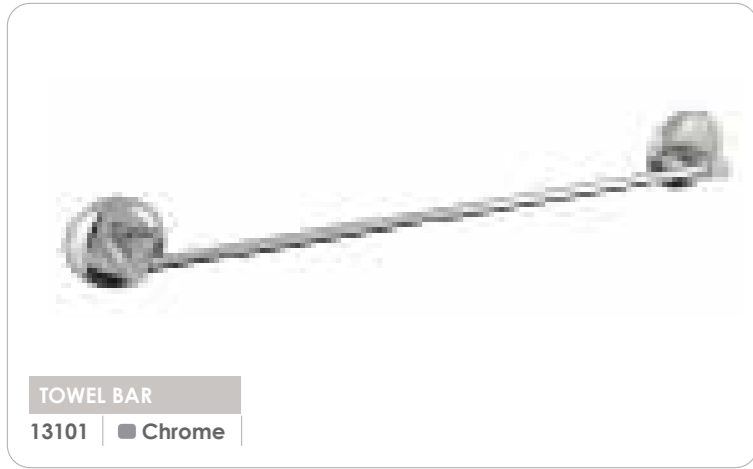

TOWEL BAR
13101 | Chrome

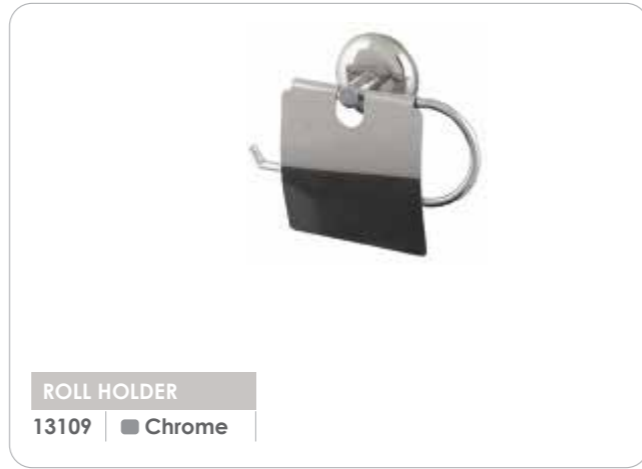

ROLL HOLDER
13109 | Chrome



TOWEL RING
13102 | Chrome

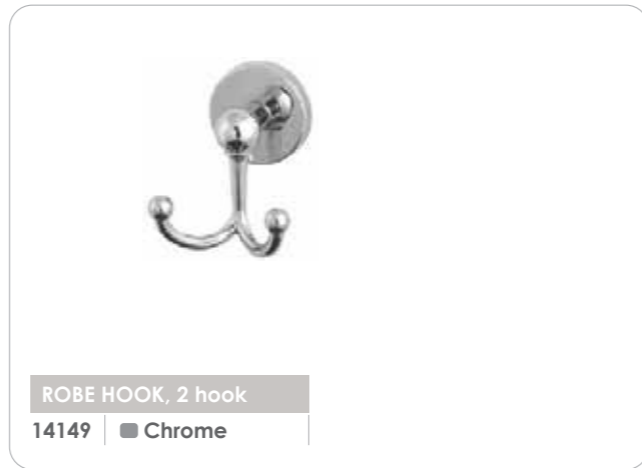

ROBE HOOK, 2 hook
14149 | Chrome

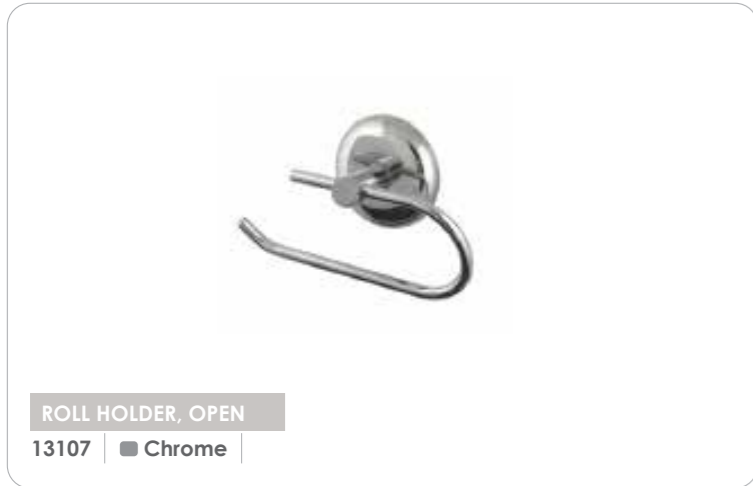

ROLL HOLDER, OPEN
13107 | Chrome

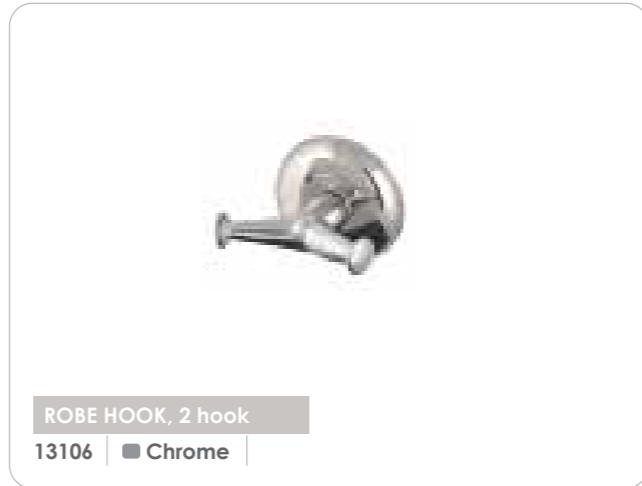

ROBE HOOK, 2 hook
13106 | Chrome



SOAP DISH
13104 | Chrome



TUMBLER HOLDER
13105 | Chrome

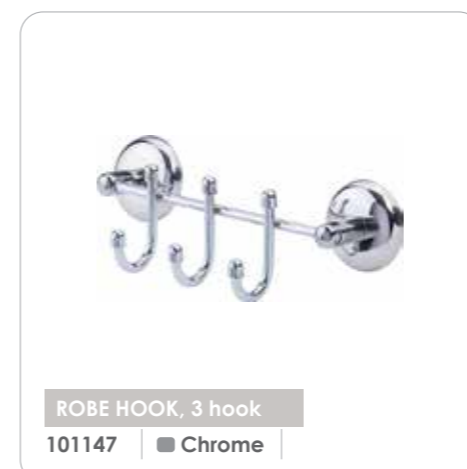

ROBE HOOK, 3 hook
101147 | Chrome

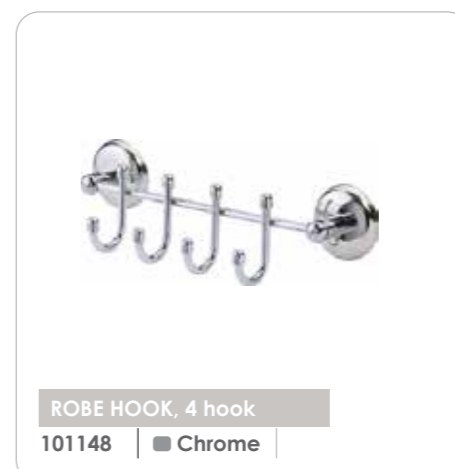

ROBE HOOK, 4 hook
101148 | Chrome

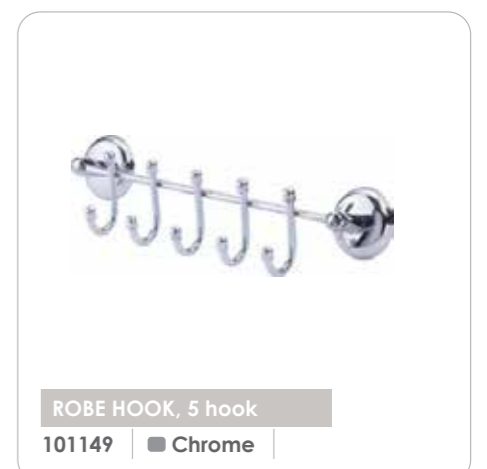

ROBE HOOK, 5 hook
101149 | Chrome



GLAS SHELF
13103 | Chrome



SET
13124 | Chrome



SOAP BASKET, 1 Shelf
15145 | Polished Stainless Steel



SOAP BASKET, 2 Shelf
15146 | Polished Stainless Steel





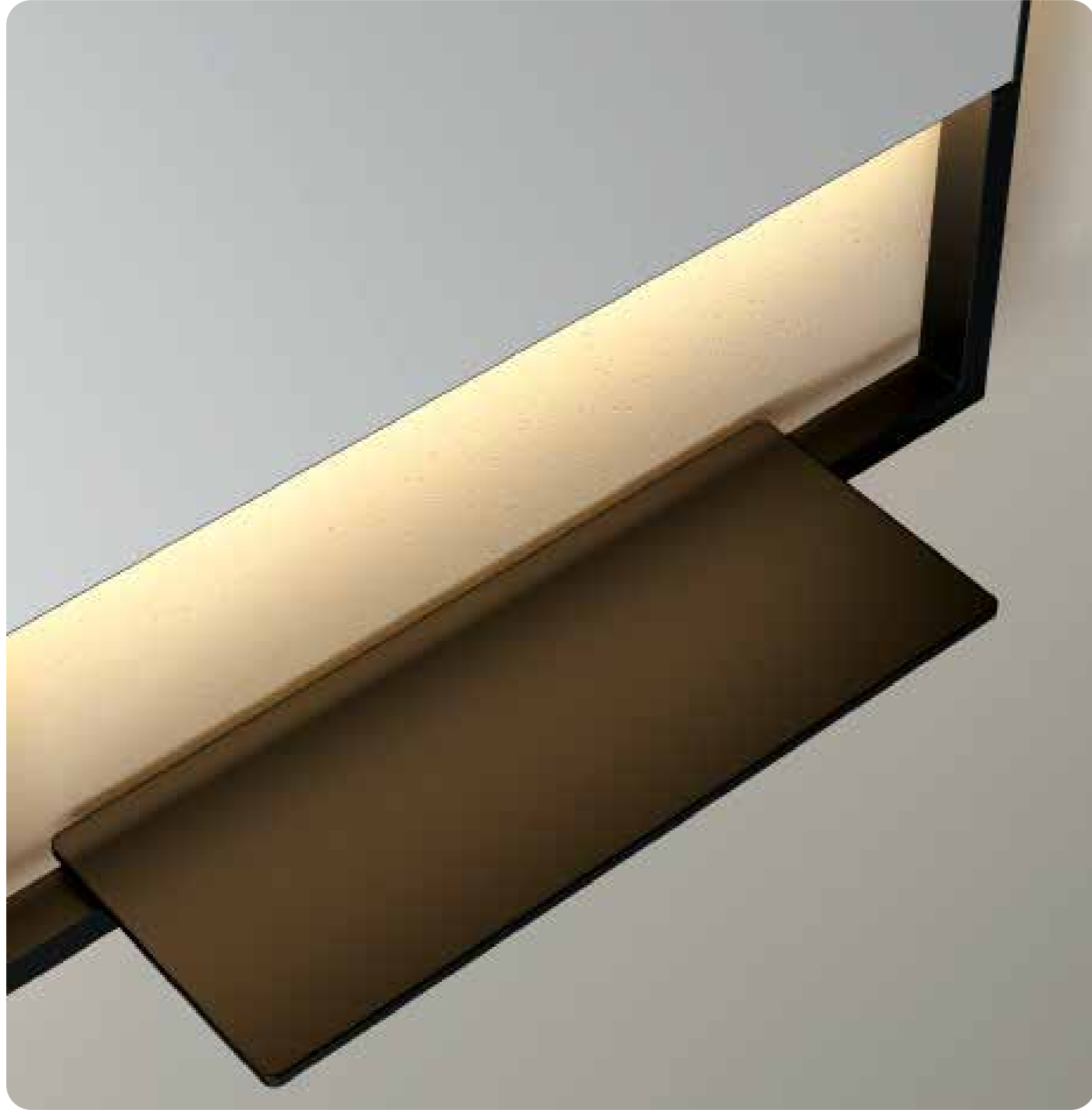

SOAP BASKET, 3 Shelf
15148 | Polished Stainless Steel

The background of the image is a classic marbled pattern, often referred to as 'stone' or 'shell' marble. It features a complex, organic design with swirling, vein-like structures in various shades of light gray, off-white, and pale beige. The lines are irregular and fluid, creating a sense of depth and movement. The overall appearance is that of a natural stone surface.

Mirrors



	Sensor	(Q)
	Touch	(W)
	Anti-Fog	(Z)
	Magnifier	(X)

› Sensor, Touch, Anti-Fog Magnifier optional features.

› Place your order by adding the feature symbol of the product you want to purchase to the end of the product code.

› Sensor (Q), Touch (W), Anti-Fog (Z), Magnifier (X)

› Please inquire for different sizes and features.

- › Optional touch feature.
- › Get information for special dimensions.
- › LED color is daylight.



MIRROR

612018 | Direct Connect Ø 700mm | Black



- ▶ Optional touch feature.
- ▶ Get information for special dimensions.
- ▶ LED color is daylight.

MIRROR
612022 | Direct Connect 800x600 mm ■ Black



- ▶ Optional touch feature.
- ▶ Get information for special dimensions.
- ▶ LED color is daylight.

MIRROR
612012 | Direct Connect 1000x700 mm ■ Black
612014 | Direct Connect 800x600 mm ■ Black



- ▶ Optional touch feature.
- ▶ Get information for special dimensions.
- ▶ LED color is daylight.

MIRROR
612016 | Direct Connect Ø 700mm ■ Black



- ▶ Optional touch feature.
- ▶ Get information for special dimensions.
- ▶ LED color is daylight.

MIRROR
612024 | Direk Bağlantılı Ø 700mm ■ Black



- ▶ Optional touch feature.
- ▶ Get information for special dimensions.
- ▶ LED color is daylight.

MIRROR
612034 Vertical, Direct Connect 800x600 mm ■ Black



- ▶ Sensor, Touch, Anti-Fog Magnifier optional features.
- ▶ Get information for special dimensions.
- ▶ LED color is daylight.

MIRROR
612057 Direct Connect Ø 700mm



- › Sensor, Touch, Anti-Fog Magnifier optional features.
- › Get information for special dimensions.
- › LED color is daylight.

MIRROR

612056 | Direct Connect Ø 700mm



- › Sensor, Touch, Anti-Fog Magnifier optional features.
- › Get information for special dimensions.
- › LED color is daylight.

MIRROR

612058 | Direct Connect Ø 700mm



- › Sensor, Touch, Anti-Fog Magnifier optional features.
- › Get information for special dimensions.
- › LED color is daylight.

MIRROR

612072 | Direct Connect Ø 700mm



- › Sensor, Touch, Anti-Fog Magnifier optional features.
- › Get information for special dimensions.
- › LED color is daylight.

MIRROR

612064 | Direct Connect 1000x700 mm
612066 | Direct Connect 800x600 mm



- › Sensor, Touch, Anti-Fog Magnifier optional features.
- › Get information for special dimensions.
- › LED color is daylight.

MIRROR

612076	On/Off 1000x700 mm	■ Aluminum
612078	On/Off 800x600 mm	■ Aluminum



- › Sensor, Touch, Anti-Fog Magnifier optional features.
- › Get information for special dimensions.
- › LED color is daylight.

MIRROR

612088	On/Off 1000x700 mm	■ Aluminum
612090	On/Off 800x600 mm	■ Aluminum



- ▶ Sensor, Touch, Anti-Fog Magnifier optional features.
- ▶ Get information for special dimensions.
- ▶ LED color is daylight.

MIRROR		
612108	On/Off 1000x700 mm	■ Aluminum
612110	On/Off 800x600 mm	■ Aluminum



- ▶ Sensor, Touch, Anti-Fog Magnifier optional features.
- ▶ Get information for special dimensions.
- ▶ LED color is daylight.

MIRROR		
612100	On/Off 1000x700 mm	■ Aluminum
612102	On/Off 800x600 mm	■ Aluminum



- › Sensor, Touch, Anti-Fog Magnifier optional features.
- › Get information for special dimensions.
- › LED color is daylight.

MIRROR

612104	On/Off 1000x700 mm	■ Aluminum
612106	On/Off 800x600 mm	■ Aluminum



- › Sensor, Touch, Anti-Fog Magnifier optional features.
- › Get information for special dimensions.
- › LED color is daylight.

MIRROR

612044	On/Off 1000x700 mm	■ Aluminum
612046	On/Off 800x600 mm	■ Aluminum

Economic Mirrors



Mirror

42117	400x500mm
42119	450x600mm
42130	Hookless 400x600mm

> Get information for special dimensions.



Mirror, Double Glass

42123	500x700mm
-------	-----------





























RÖNESANS GÖZTEPE STADI / İZMİR
RÖNESANS HAVA HARP OKULU / FLORYA
RÖNESANS KALE ŞANTİYESİ / ANKARA
RÖNENS TOKİ / İZMİR
RÖNESANS DEPREM KONUTLARI / ANTAKYA
RÖNESANS DEPREM KONUTLARI / DEFNE
RÖNESANS DEPREM KONUTLARI / MALATYA
SWISS OTEL / ÇEŞME
ARTAŞ VADİSTANBUL 1. ETAP / İSTANBUL
ARTAŞ VADİSTANBUL 3. ETAP / İSTANBUL
ARTAŞ KALE / İSTANBUL
ARTAŞ ATAKÖY OFİS / İSTANBUL
ARTAŞ YAMAEVLER 1. ETAP / İSTANBUL
ARTAŞ ECLİPSE / MASLAK
ARTAŞ - MESA - KANTUR - TEMA / İSTANBUL
İNVEST VADİ KORU / İSTANBUL
İNVEST VADİPARK / İSTANBUL
İVEST MASLAK KORU / İSTANBUL
İNVEST VADİ/ İSTANBUL
İNVEST VADİSTANBUL TERAS / İSTANBUL
RAMS BAĞÇEŞEHİR / İSTANBUL
ORYATAŞ İNŞAAT / ORYAPARK / İSTANBUL
ERGİN EVLER 3. ETAP / BURSA
AĞAOĞLU CADDE / İSTANBUL
SEBA İNŞAAT - ETİLER ALA EVLERİ / İSTANBUL
ASELSAN / ANKARA
HAVELSAN / ANKARA
TEKNOPARK / İSTANBUL
CRESCENT MALL / AZERBAJYAN
MAYAR RESİDENCE / İSTANBUL
SEMBOL İNŞAAT / İSTANBUL
TEKNİK YAPI EVORA / İSTANBUL
TEKNİK YAPI EVORA / DENİZLİ
TEKNİK YAPI - METROPARK / İSTANBUL
TEKNİK YAPI CONCORD / İSTANBUL
TEKNİK YAPI SUADİYE SAHİL / İSTANBUL
FERKO İNŞAAT - PAPURİS PLAZA
ROMATEM KISIKLI REHABİLİTASYON MERKEZİ
HİLTON BOSPHORUS / TAKSİM

HİLTON / ANKARA
HİLTON / MERSİN
HİLTON / ADANA
HİLTON / BODRUM
DOUBLE TREE BY HİLTON / ŞANLIURFA
SHERATON OTEL LEVET / İSTANBUL
MÖVENPICK HOTEL & RESORT / KURTKÖY
FOUR POINT BY SHERATION / KAĞITHANE
FOUR POINT BY SHERATION / İZMİR
RAMADA / İZMİR
RİXOS / GÜRCİSTAN
RİXOS TERSANE / İSTANBUL
FERKO İNŞAAT / ILGAZ MOUNTAIN HOTEL & CROWNE PLAZA / ÜMRANİYE
BOLU KORU HOTELS / BOLU
İBİS OTEL / MERTER
İBİS OTEL / TUZLA
THE PARAMOUNT OTEL / BODRUM
RADİSSON / ATAŞEHİR
PARK İNN BY RADİSSON / DUDULLU
ANEMON HOTELS / MANİSA
ANEMON HOTELS / GALATA
ANEMON HOTELS / İZMİR
ANEMON HOTELS / İSKENDURUN
ANEMON HOTELS / SAMSUN
ANEMON HOTELS / UŞAK
ANEMON HOTELS / ESKİŞEHİR
POINT OTEL / ANKARA
FAİRMONT HOTEL & RESORT / İSTANBUL
PALOMA FINESS / ANTALYA
SURAL SARAY OTEL / ANTALYA
DARKHİLL OTEL / İSTANBUL
BAVER OTEL / İSTANBUL
GLEAM COLLECTION HOTEL / İSTANBUL
BLUE DREAMS RESORT / BODRUM
BOF HOTEL / ULUDAĞ
BOF HOTEL / DUDULLU
BOF OTEL / İMES

LİMAK DELUX OTEL / KIBRIS
GİRAY YAPI - CITYLOFT RESİDENCE INN BY
GİRAY YAPI - CITYLOFT 161 OTEL / İSTANBUL
GİRAY YAPI - CITYLOFT 81 OTEL / İSTANBUL
GİRAY YAPI - CITYLOFT 64 OTEL / İSTANBUL
ENDLESS HOTEL / TAKSİM
LUSH HOTEL / TAKSİM
SABANCI ÜNİVERSİTESİ OTEL / İSTANBUL
LADY DİANA HOTEL / İSTANBUL
VİTAL FULYA OTEL / İSTANBUL
SOFİTEL OTEL / İSTANBUL
NOVA PLAZA PERA OTEL / İSTANBUL
THE HALIÇ OTEL / İSTANBUL
İSTANBUL HOTEL & SPA BOMONTİ / İSTANBUL
SÖĞÜT OTEL / İSTANBUL
ÖMER HOLIDAY RESORT / KUŞADASI
TRENDYOL OFİS / İSTANBUL
GARANTİ BANKASI BÖLGE MÜDÜRLÜĞÜ /
İŞ BANKASI / İSTANBUL
AKBANK / İSTANBUL
KOLLEKTİF HAUSE / İSTANBUL
GOOGLE / İSTANBUL OFİS
EMLAK KONUT - TEKNİK YAPI EVORA / İSTAN-
ABDİ İBRAHİM MERKEZ OFİS / İSTANBUL
METROPORT AVM / İSTANBUL
BRANDIUM AVM / İSTANBUL
M1 AVM / ADANA
PARAGN AVM / AYVALIK
PALLADIUM AVM / İSTANBUL
İNEGÖL AVM / BURSA
MARMARA FORUM AVM / İSTANBUL
PLATO AVM / İSTANBUL
ETİ MADEN MERKEZ / ANKARA
VARYAP MERIDIAN / İSTANBUL
EMİN EVİM HOLDİNG MERKEZ OFİS / İSTAN-
TOKİ İZMİR TOPLU KONUT
TOKİ ŞIRNAK TOPLU KONUT
TOKİ MALATYA TOPLU KONUT

TOKİ ZONGULDAK-DEVREK TOPLU KONUT
TOKİ ZONGULDAK-GÖKÇEBEY TOPLU KONUT
TOKİ ŞİLE TOPLU KONUT
TOKİ KÜTAHYA- ALTINDAĞ TOPLU KONUT
TOKİ SİMAV TOPLU KONUT
TOKİ MANİSA TOPLU KONUT
TOKİ MANİSA TOPLU KONUT
TOKİ MERSİN OKUL
TOKİ KAHRAMANMARAŞ OKUL
TOKİ VAN MİLLET BAĞÇESİ
KREDİ YURTLAR KURUMU - TOKİ - TEFİROM
KREDİ YURTLAR KURUMU - TEFİROM - 3.000
KREDİ YURTLAR KURUMU - TOKİ KARAMAN
TEFİROM - SÜLEYMAN DEMİREL ÜNİVERSİTESİ
YTONG FABRİKA DİLOVASI / İZMİR
LC WAIKIKI MERKEZ OFİS / İSTANBUL
OPET İSTASYONLARI
İGA İSTANBUL HAVALİMANI / İSTANBUL
SAĞLIK BAKANLIĞI BORNOVA DEVLET HAS-
SAĞLIK BAKANLIĞI BUCAK DEVLET HASTAN-
SAĞLIK BAKANLIĞI ALANYA DEVLET HASTA-
MEDICANA HASTANESİ / ATAŞEHİR
HİSAR HASTANESİ / ÜMRANİYE
EREN HASTANESİ / ATAŞEHİR
İSTANBUL ONKOLOJİ HASTANESİ / MALTEPE
MALTEPE GÖRÜNTÜLEME MERKEZİ / İSTAN-
SUR HASTANESİ / ÜMRANİYE
KANSERE KARŞI BİRLİKTE DERNEĞİ / KAYSERİ
İZMİR ÖZEL TÜRK KOLEJİ
DOĞA KOLEJİ / İSTANBUL
YEDİTEPE ÜNİVERSİTESİ / İSTANBUL
İSTEK OKULLARI / İSTANBUL
ORDU B.B.
İSPER / İSTANBUL B.B.
SAKARYA ŞEHİR STADI
SİVAS ŞEHİR STADI
GÖZTEPE ŞEHİR STADI
GİRESUN ŞEHİR STADI

Referanslarımız

Referanslarımız

Banyo Ölçüleri



T.C.
TÜRK PATENT ve MARKA KURUMU
MARKA TESCİL BELGESİ
Marka No : 2020 58020 - Ticaret

Line
Bathroom Accessories

Marka Sahibi : GLOBALLINE BANYO VE OTEL EKİPMANLARI SANAYİ VE TİCARET LİSTİŞL.
TÜRKİYE CUMHURİYETİ
MİNAR SİNAN MAİL KIBRIS CAD. NO:15/A Akşehir /Konya

Emtia : 06/11
İlişkilidir.

İşbu Marka 04/06/2020 tarihinden itibaren ON YIL süreyle
18/01/2021 tarihinde tescil edilmiştir.



Prof. Dr. Habip ASAN
Türk Patent ve Marka
Kurumu Başkanı

TURK PATENT
TÜRK PATENT VE MARKA KURUMU



- Fiyatlarımıza KDV (%18) dahil değildir.
- GLOBALLINE BANYO VE OTEL EKİPMANLARI SAN. VE TİC. LTD. ŞTİ. önceden haber vermeksizin ürün özellikleri ve fiyatları değiştirme hakkına sahiptir.
- Tipografik hatalardan firmamız sorumlu değildir.

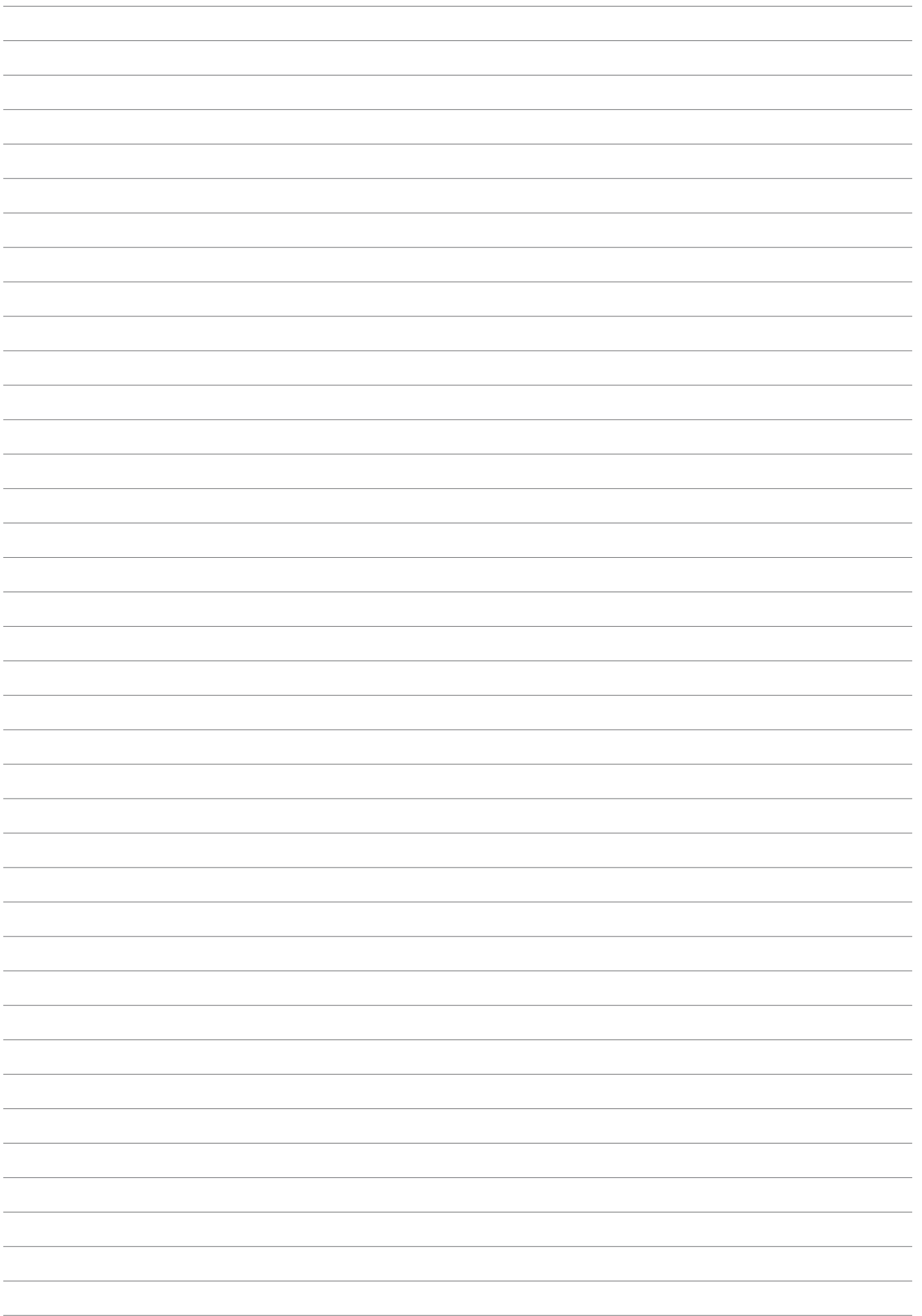



Line

Bathroom Accessories

GLOBALLINE BANYO VE OTEL EKİPMANLARI SAN. VE TİC. LTD. ŞTİ.
Mimar Sinan Mahallesi Kıbrıs Caddesi No: 138/A PK:34779 Ataşehir / İSTANBUL
T. +90 216 471 15 94
www.globalline.com.tr / info@globalline.com.tr